



DAMIANO
LATINI

#DamianoLatini
#italiandesign

COLLECTION 2017 - 2018



#DamianoLatini
#italiandesign



C O L L E C T I O N 2 0 1 7 - 2 0 1 8

TEAM



“ *Quando penso alle mie creazioni le immagino al servizio della creatività e dello stile delle persone, come tasselli della loro personalità in continua evoluzione* ”

DAMIANO LATINI

CREATIVE COMBOS

Venti anni fa, quando la nostra azienda muoveva i primi passi nel mondo delle cucine, non avremmo mai pensato di diventare in poco tempo fra i più importanti fornitori di brand nazionali e internazionali. Alla produzione di maniglie ben presto abbiamo affiancato quella dei sottopensili e dei complementi d'arredo, che rappresentano ora il nostro fiore all'occhiello in quanto a creatività, funzionalità e design innovativo. Il vostro spazio abitativo, i gesti quotidiani, le differenti esigenze legate alle abitudini e alla personalità di ognuno, sono da sempre ciò che ci spinge ad immaginare nuove creazioni; nel frattempo, probabilmente, alcune di esse fanno già parte della vostra vita senza che voi lo sappiate. Ogni prodotto nasce per dare la possibilità di progettare e arredare qualsiasi ambiente in modo semplice e funzionale. Forme, colori e materiali sono per l'azienda gli strumenti per creare combinazioni originali e soluzioni innovative.

Twenty years ago, when we took our first steps in the world of kitchens, we would never have thought about becoming in a short time one of the most important suppliers to many domestic and international brands. Very soon we added to the handles production the manufacturing of kitchen racks and furnishing accessories, which now represents our flagship as creativity, functionality and innovative design. Your living space, your everyday life, your own habits and needs are what keeps us imagining new creations. In the meantime, perhaps some of them are already part of your life without you even knowing. Each of our produces is created to allow you to design and furnish any space in an easy and functional way. Shapes, colours and materials are our working tools to create original combinations and innovative solutions.

20 лет назад, когда наша компания совершала первые шаги в мире кухонь, мы никогда не думали, что в скором времени станем одним из лидирующих поставщиков национальных и интернациональных брендов кухонь. Помимо производства ручек, мы добавили производство рейлинговых систем и мебельных аксессуаров, которые стали нашей гордостью благодаря креативности, функциональности и инновационному дизайну. Ваше жилое пространство, повседневные жесты, разные требования из-за привычек и характеров каждого, это то, что всегда толкает на создание новых творений, тем временем, когда некоторые из них уже, возможно, стали частью Вашей жизни, а вы даже этого не знали. Каждый продукт создается, чтобы дать возможность спроектировать и обустроить любое помещение в простой и функциональный способ. Формы, цвета и материалы являются инструментами, которые компания использует, чтобы создавать оригинальные комбинации и инновационные решения



DAMIANO LATINI
Via Sandro Pertini, 63812 - Montegranaro (FM) Italy
T +39 0734 894144 - info@damianolatini.it
www.damianolatini.it

COMPLEMENTI D'ARREDO



SOTTOPENSIILI

INDICE / CONTENTS / ОГЛАВЛЕНИЕ

DAMA p. 8 - 17	DAMA L p. 18 - 25	GIOSTRA p. 26 - 35
GIOSTRA L p. 36 - 41	TOTEM p. 42 - 49	TECA p. 50 - 55
FLY p. 56 - 61	SUN p. 62 - 67	TRIGA p. 68 - 73
PRATIKA p. 74 - 79	COMPACT p. 80 - 85	MONDRIAN p. 86 - 91
FIRKANT p. 92 - 97	TRIGA SLIM p. 98 - 103	HORIZON p. 104 - 109
BLADE HOB p. 110 - 115	HORIZON BIG p. 116 - 121	ACCESSORI p. 122 - 143

COLLECTION 2017 - 2018



DAMA

Essenziale e versatile, dama è una struttura di alluminio con diverse misure a seconda delle esigenze di spazio o di organizzazione degli elementi che deve contenere. Grazie a una vasta gamma di componenti a scelta, è perfetta sia per il bagno che per la cucina, trasformandosi in un attimo da semplice accessorio in vero e proprio complemento di arredo.

Essential and versatile. Dama is a structure made of aluminium in different sizes that you can adapt according to your own space requirements and your favourite objects arrangement. Thanks to a wide range of components available to pick and choose, it is perfect for both the bathroom and the kitchen, turning an ordinary accessory into a real piece of furniture.

Аксессуар дама – существенный и многоцелевой, эта структура из алюминия разных размеров удовлетворит все требования к доступному пространству и уместит все необходимые предметы. Благодаря широкой гамме дополнительных компонентов на ваш выбор, дама подойдет идеально как для ванной, так и для кухни. Она превратиться из простого аксессуара в настоящий предмет мебели.





DAMA



DAMA

DAMA 360

Materiale / Materials / МАТЕРИАЛ
Alluminio / Aluminium / Алюминий

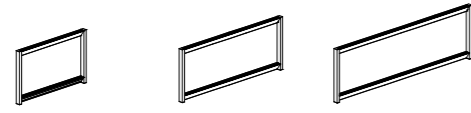

	360 x 600	360 x 900	360 x 1200
Kg.	1.4	1.8	2.2
L cm	60.0	90.0	120.0
H cm	36.0	36.0	36.0
P cm	3.0	3.0	3.0
X cm	31.6	31.6	31.6

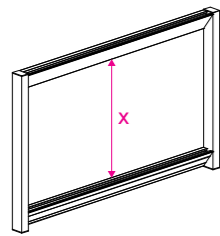

-  Verniciato ghisa
Painting cast iron
ОКРАСКА ЧУГУН
-  Verniciato bianco
Painting white
ОКРАСКА БЕЛЫЙ
-  Verniciato
Painting
ОКРАСКА

DAMA 360E

Materiale / Materials / МАТЕРИАЛ
Alluminio / Aluminium / Алюминий

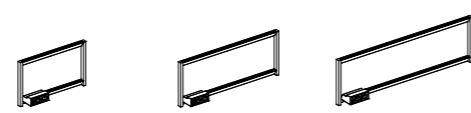

	360 x 600	360 x 900	360 x 1200
Kg.	2.1	2.5	2.9
L cm	60.0	90.0	120.0
H cm	36.0	36.0	36.0
P cm	14.0	14.0	14.0
X cm	31.6	31.6	31.6

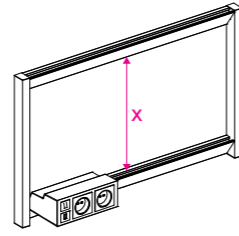

-  Verniciato ghisa
Painting cast iron
ОКРАСКА ЧУГУН
-  Verniciato bianco
Painting white
ОКРАСКА БЕЛЫЙ
-  Verniciato
Painting
ОКРАСКА



DAMA 720

Materiale / Materials / МАТЕРИАЛ
Alluminio / Aluminium / Алюминий



	720 x 600	720 x 900	720 x 1200
Kg.	2.3	2.9	3.5
L cm	60.0	90.0	120.0
H cm	72.0	72.0	72.0
P cm	3.0	3.0	3.0
X cm	33.8	33.8	33.8

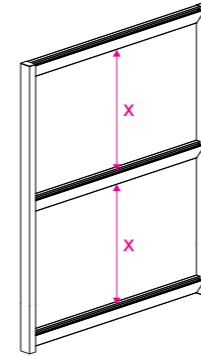

-  Verniciato ghisa
Painting cast iron
ОКРАСКА ЧУГУН
-  Verniciato bianco
Painting white
ОКРАСКА БЕЛЫЙ
-  Verniciato
Painting
ОКРАСКА

DAMA 720E

Materiale / Materials / МАТЕРИАЛ
Alluminio / Aluminium / Алюминий

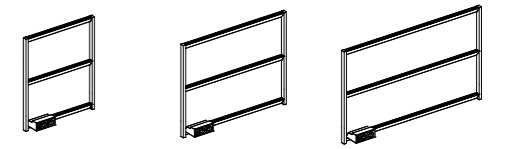

	720 x 600	720 x 900	720 x 1200
Kg.	3.0	3.6	4.2
L cm	60.0	90.0	120.0
H cm	72.0	72.0	72.0
P cm	14.0	14.0	14.0
X cm	33.8	33.8	33.8

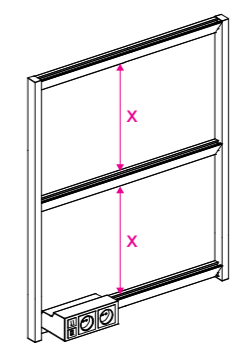

-  Verniciato ghisa
Painting cast iron
ОКРАСКА ЧУГУН
-  Verniciato bianco
Painting white
ОКРАСКА БЕЛЫЙ
-  Verniciato
Painting
ОКРАСКА

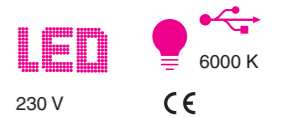

DAMA 600

Materiale / Materials / МАТЕРИАЛ
Alluminio / Aluminium / Алюминий

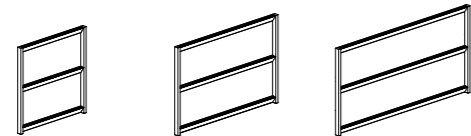

	600 x 600	600 x 900	600 x 1200
Kg.	2.0	2.6	3.2
L cm	60.0	90.0	120.0
H cm	60.0	60.0	60.0
P cm	3.0	3.0	3.0
X cm	27.8	27.8	27.8

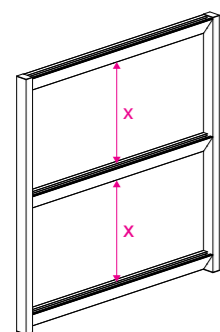

-  Verniciato ghisa
Painting cast iron
ОКРАСКА ЧУГУН
-  Verniciato bianco
Painting white
ОКРАСКА БЕЛЫЙ
-  Verniciato
Painting
ОКРАСКА

DAMA 600E

Materiale / Materials / МАТЕРИАЛ
Alluminio / Aluminium / Алюминий

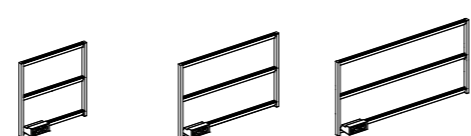

	600 x 600	600 x 900	600 x 1200
Kg.	2.7	3.3	3.9
L cm	60.0	90.0	120.0
H cm	60.0	60.0	60.0
P cm	14.0	14.0	14.0
X cm	27.8	27.8	27.8

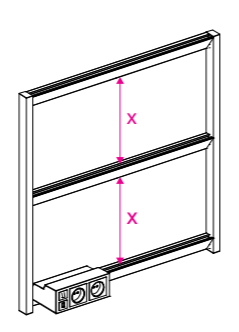

-  Verniciato ghisa
Painting cast iron
ОКРАСКА ЧУГУН
-  Verniciato bianco
Painting white
ОКРАСКА БЕЛЫЙ
-  Verniciato
Painting
ОКРАСКА







DAMA 960

Materiale / Materials / МАТЕРИАЛ
Alluminio / Aluminium / Алюминий

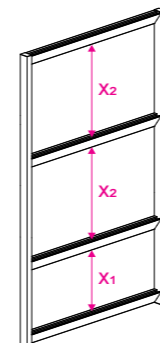

	960 x 600	960 x 900	960 x 1200
Kg.	3.3	3.7	4.6
L cm	60.0	90.0	120.0
H cm	96.0	96.0	96.0
P cm	3.0	3.0	3.0
X1 cm	24.0	24.0	24.0
X2 cm	33.8	33.8	33.8



-  Verniciato ghisa
Painting cast iron
ОКРАСКА ЧУГУН
-  Verniciato bianco
Painting white
ОКРАСКА БЕЛЫЙ
-  Verniciato
Painting
ОКРАСКА

DAMA 960E

Materiale / Materials / МАТЕРИАЛ
Alluminio / Aluminium / Алюминий





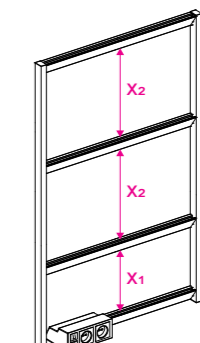

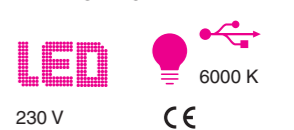

	960 x 600	960 x 900	960 x 1200
Kg.	4.0	4.4	5.3
L cm	60.0	90.0	120.0
H cm	96.0	96.0	96.0
P cm	14.0	14.0	14.0
X1 cm	24.0	24.0	24.0
X2 cm	33.8	33.8	33.8

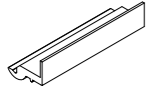
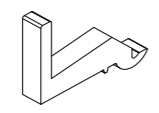
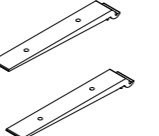

-  Verniciato ghisa
Painting cast iron
ОКРАСКА ЧУГУН
-  Verniciato bianco
Painting white
ОКРАСКА БЕЛЫЙ
-  Verniciato
Painting
ОКРАСКА

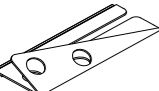
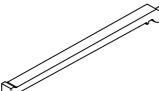
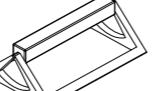

Accessori / Accessories / Аксессуары

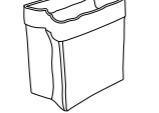
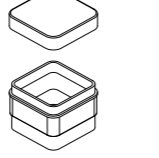
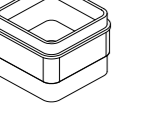
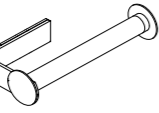
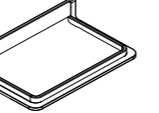
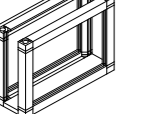
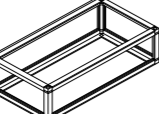
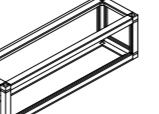
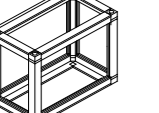
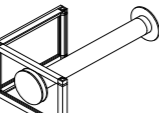
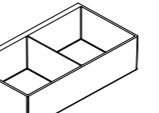
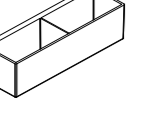
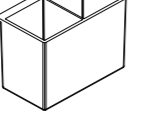
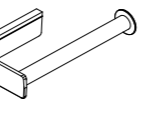
	Adattatore Adapter адаптор pagina 135		Gancio Hanger крючок pagina 134		Reggimensola Shelf support полкодержатель pagina 134
	Mensola 270 Shelf 270 полка 270 pagina 132		Mensola 450 Shelf 450 полка 450 pagina 132		Mensola 600 Shelf 600 полка 600 pagina 132
	Portabottiglie Bottle holder держатель для бутылок pagina 135		Portapentole Support pots держатель для кастрюль pagina 133		Portarotolo Roll holder держатель для бумажного полотенца pagina 133
	* Mensola legno 22 * Wood shelf 22 * деревянная полка 22 pagina 138		* Contenitori * Containers * контейнеры pagina 140		* Contenitori * Containers * контейнеры pagina 126
	* Contenitori * Containers * контейнеры pagina 126		* Portarotolo Roll holder держатель для бумажного полотенца pagina 127		* Mensola Shelf полка pagina 126
	* Portatovaglioli Napkins holder держатель для салфеток pagina 129		* Portabarrattoli Jars holder держатель для баночек pagina 128		* Portaspezie Spices holder держатель для специй pagina 128
	* Portaposate Cutlery holder держатель для столовых приборов pagina 128		* Portarotolo Roll holder держатель для бумажного полотенца pagina 129		* Portabarrattoli Jars holder держатель для баночек pagina 124
	* Portaspezie Spices holder держатель для специй pagina 124		* Portaposate Cutlery holder держатель для столовых приборов pagina 124		* Portarotolo Roll holder держатель для бумажного полотенца pagina 125

* Abbinare un accessorio ad un adattatore
Match an accessory to an adapter
Использовать один адаптор для крепления
контейнера

* Abbinare due ganci ad un sacchetto contenitore
Match two hooks to a container bag
Использовать два крючка для бумажного мешка –
контейнера

* Abbinare una coppia di staffe reggimensola alla mensola
Match a pair of brackets to the shelf
Использовать пару полкодержателей для одной полки





DAMA L

Pratica ed elegante, Dama L è una struttura con profili di alluminio componibili, espandibile a seconda delle esigenze di spazio. Naturale evoluzione di Dama, è dotata di supporti a 90° nella parte superiore per distanziarla dalla parete e di piedini regolabili nella parte inferiore per un preciso e stabile appoggio a pavimento. Grazie a una vasta gamma di componenti, può diventare un meraviglioso orto verticale interno, dotato di luci fitostimolanti che aiutano le piante officinali a crescere in casa.

Practical and elegant. Dama L is a fitted structure made of aluminium profiles and a completely bespoke piece to your specific measurements. It is dama natural evolution. It is equipped with 90-degree supports at the top to distance it from the wall and adjustable feet at the bottom for a precise and stable floor stand. Thanks to a wide range of components you can even use it as a wonderful, upright interior garden, equipped with phyto-stimulating lights to help you grow officinal plants at the home.

Дама эль, практичная и элегантная структура из алюминиевых компонуемых профилей, наращиваемых в зависимости от требований пространства. Это естественная эволюция системы дама, дополнена держателями под углом 90 градусов на верхней части с креплением к стене, и регулируемые ножками в нижней части для устойчивой фиксации на полу. Благодаря широкой гамме компонентов, может превратиться в прекрасный вертикальный сад, она снабжена фито - стимулирующим светом, который способствует росту растений в закрытом помещении



AWARD 2017
Shortlisted



DAMA L



DAMA L

DAMA L 140

Materiale / Materials / МАТЕРИАЛ
Alluminio / Aluminium / Алюминий



140 x 60 140 x 90 140 x 120

Kg.	4.2	5.3	7.3
L cm	64.0	94.0	126.0
L1 cm	60.0	90.0	60.0
H cm (min-max)	142.8 - 145.8	142.8 - 145.8	142.8 - 145.8
P cm	15.0	15.0	15.0
X1 cm (min-max)	32.8 - 35.8	32.8 - 35.8	32.8 - 35.8
X2 cm	30.0	30.0	30.0
X3 cm (min-max)	-	-	17.8 - 20.8
X4 cm (min-max)	-	-	32.8 - 35.8

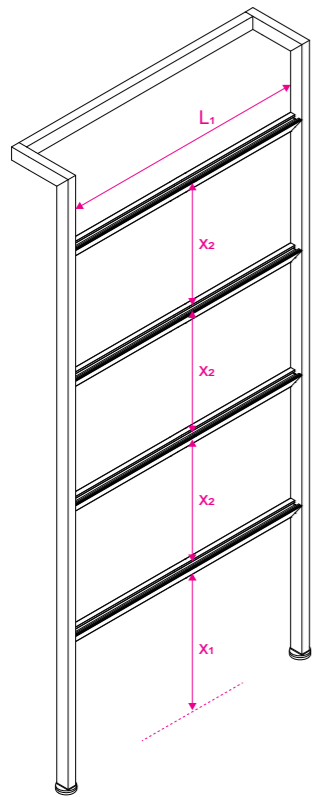

-  Verniciato ghisa
Painting cast iron
ОКРАСКА ЧУГУН
-  Verniciato bianco
Painting white
ОКРАСКА БЕЛЫЙ
-  Verniciato
Painting
ОКРАСКА

DAMA L 140E

Materiale / Materials / МАТЕРИАЛ
Alluminio / Aluminium / Алюминий



140 x 60 140 x 90 140 x 120

Kg.	4.2	5.3	7.3
L cm	64.0	94.0	126.0
L1 cm	60.0	90.0	60.0
H cm (min-max)	142.8 - 145.8	142.8 - 145.8	142.8 - 145.8
P cm	15.0	15.0	15.0
X1 cm (min-max)	32.8 - 35.8	32.8 - 35.8	32.8 - 35.8
X2 cm	30.0	30.0	30.0
X3 cm (min-max)	-	-	17.8 - 20.8
X4 cm (min-max)	-	-	32.8 - 35.8

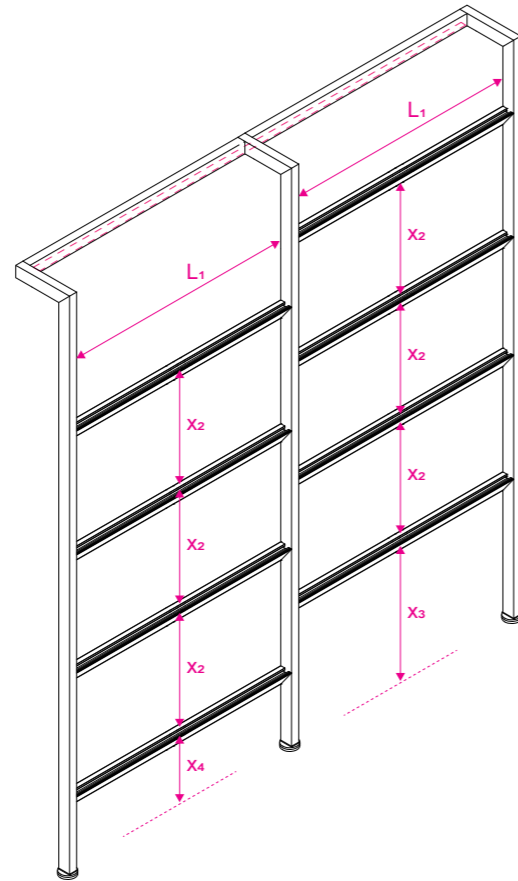

-  Verniciato ghisa
Painting cast iron
ОКРАСКА ЧУГУН
-  Verniciato bianco
Painting white
ОКРАСКА БЕЛЫЙ
-  Verniciato
Painting
ОКРАСКА



DAMA L 180



Materiale / Materials / МАТЕРИАЛ
Alluminio / Aluminium / Алюминий

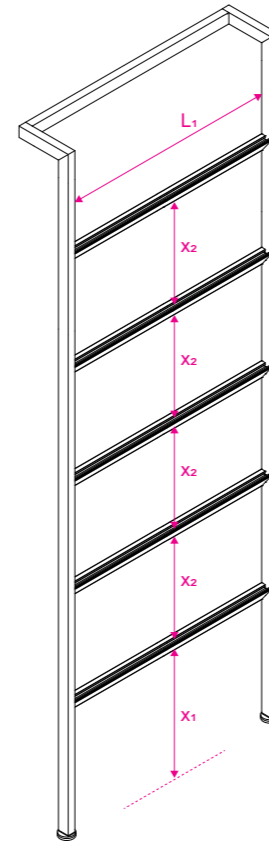

180 x 60 180 x 90 180 x 120

Kg.	5.1	6.5	9.3
L cm	64.0	94.0	126.0
L1 cm	60.0	90.0	60.0
H cm (min-max)	182.8 - 185.8	182.8 - 185.8	182.8 - 185.8
P cm	15.0	15.0	15.0
X1 cm (min-max)	32.8 - 35.8	32.8 - 35.8	32.8 - 35.8
X2 cm	30.0	30.0	30.0
X3 cm (min-max)	-	-	17.8 - 20.8
X4 cm (min-max)	-	-	32.8 - 35.8



-  Verniciato ghisa
Painting cast iron
ОКРАСКА ЧУГУН
-  Verniciato bianco
Painting white
ОКРАСКА БЕЛЫЙ
-  Verniciato
Painting
ОКРАСКА

-  Verniciato ghisa
Painting cast iron
ОКРАСКА ЧУГУН
-  Verniciato bianco
Painting white
ОКРАСКА БЕЛЫЙ
-  Verniciato
Painting
ОКРАСКА



DAMA L 180E

Materiale / Materials / МАТЕРИАЛ
Alluminio / Aluminium / Алюминий







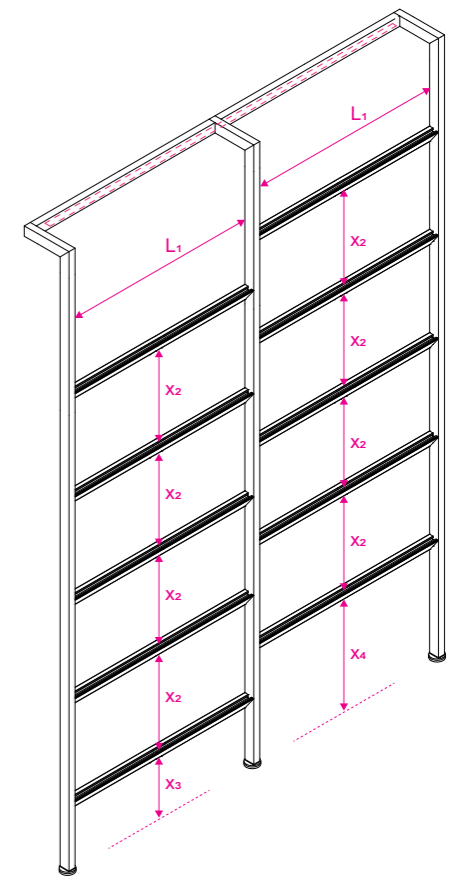

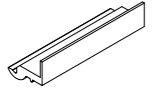
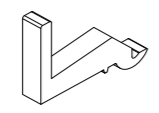
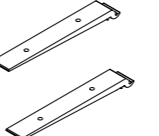

180 x 60 180 x 90 180 x 120

Kg.	5.1	6.5	9.3
L cm	64.0	94.0	126.0
L1 cm	60.0	90.0	60.0
H cm (min-max)	182.8 - 185.8	182.8 - 185.8	182.8 - 185.8
P cm	15.0	15.0	15.0
X1 cm (min-max)	32.8 - 35.8	32.8 - 35.8	32.8 - 35.8
X2 cm	30.0	30.0	30.0
X3 cm (min-max)	-	-	17.8 - 20.8
X4 cm (min-max)	-	-	32.8 - 35.8

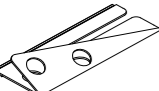
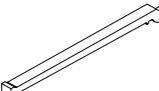
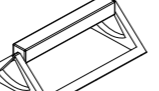

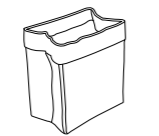
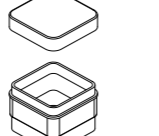
Accessori / Accessories / Аксессуары

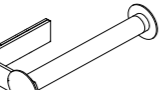
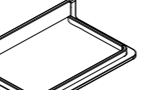
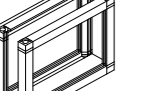
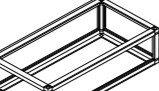
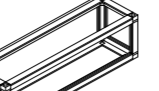
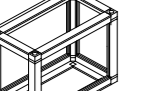
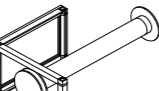
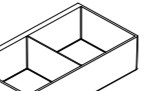
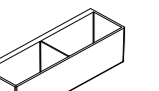
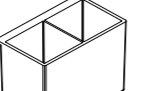
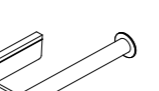
	Adattatore Adapter адаптор pagina 135		Gancio Hanger крючок pagina 134		Reggimensola Shelf support полкодержатель pagina 134
	Mensola 270 Shelf 270 полка 270 pagina 132		Mensola 450 Shelf 450 полка 450 pagina 132		Mensola 600 Shelf 600 полка 600 pagina 132
	Portabottiglie Bottle holder держатель для бутылок pagina 135		Portapentole Support pots держатель для кастрюль pagina 133		Portarotolo Roll holder держатель для бумажного полотенца pagina 133
	* Mensola legno 22 * Wood shelf 22 * деревянная полка 22 pagina 138		* Contenitori * Containers * контейнеры pagina 140		* Contenitori * Containers * контейнеры pagina 126
	* Contenitori * Containers * контейнеры pagina 126		* Portarotolo * Roll holder * держатель для бумажного полотенца pagina 127		* Mensola * Shelf * полка pagina 126
	* Portatovaglioli * Napkins holder * держатель для салфеток pagina 129		* Portabarattoli * Jars holder * держатель для баночек pagina 128		* Portaspezie * Spices holder * держатель для специй pagina 128
	* Portaposate * Cutlery holder * держатель для столовых приборов pagina 128		* Portarotolo * Roll holder * держатель для бумажного полотенца pagina 129		* Portabarattoli * Jars holder * держатель для баночек pagina 124
	* Portaspezie * Spices holder * держатель для специй pagina 124		* Portaposate * Cutlery holder * держатель для столовых приборов pagina 124		* Portarotolo * Roll holder * держатель для бумажного полотенца pagina 125

* Abbinare un accessorio ad un adattatore
Match an accessory to an adapter
Использовать один адаптор для крепления
контейнера

* Abbinare due ganci ad un sacchetto contenitore
Match two hooks to a container bag
Использовать два крючка для бумажного мешка –
контейнера

* Abbinare una coppia di staffe reggimensola alla mensola
Match a pair of brackets to the shelf
Использовать пару полкодержателей для одной полки





GIOSTRA

Lineare, funzionale, pratica. Giostra è una struttura di alluminio componibile, quanto di meglio si possa desiderare per dividere gli spazi in modo bello e razionale. Applicabile semplicemente tra pavimento e soffitto, consente di creare differenti ambienti senza chiudere la vista. Con il suo design leggero e moderno si integra perfettamente a qualsiasi ambiente, domestico o lavorativo, rendendolo più funzionale senza alterarne radicalmente la struttura.

Linear, functional, handy. Giostra is a modular structure made of aluminium, the best way to nicely and rationally divide open spaces. It is easy to attach to the floor and ceiling and it allows you to create multiple rooms without obstructing the view. Thanks to its lightweight and modern design, it fits perfectly into any space, either at home or at work, making the room extremely more functional without altering the structure.

Джостра - линейная, функциональная и практичная, структура из алюминиевых компонентов профилей. Что можно желать лучшего для разделения пространства в красивой и рациональной форме? Ее простая установка между полом и потолком, позволяет создать разные помещения, не закрывая при этом вид. Легкий и современный дизайн дополняет любые, домашние или рабочие комнаты, не внося радикальных изменений в интерьер



AWARD 2017
Shortlisted



GIOSTRA



GIOSTRA

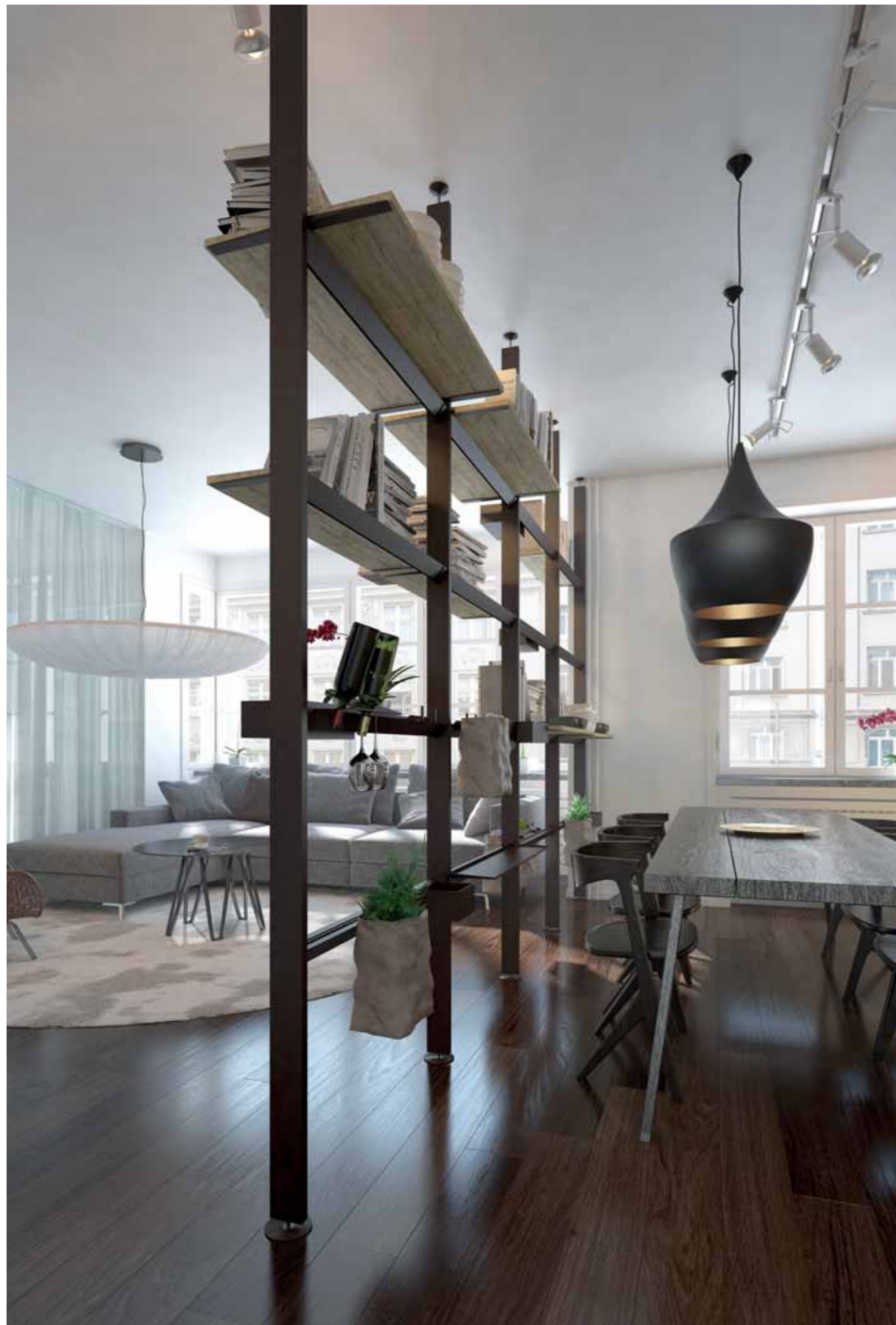

GIOSTRA



GIOSTRA

GIOSTRA 90/180/180S

Materiale / Materials / МАТЕРИАЛ
Alluminio / Aluminium / Алюминий

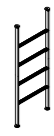

GIOSTRA/90



GIOSTRA/180



GIOSTRA/180S

	GIOSTRA/90	GIOSTRA/180	GIOSTRA/180S
Kg.	15.0	24.0	24.8
L cm	102.8	195.6	195.6
L1 cm	90.0	90.0	90.0
H cm (min-max)	266.0 - 276.0	266.0 - 276.0	266.0 - 276.0
P cm	10.0	10.0	10.0
X1 cm (min-max)	60.0 - 65.0	60.0 - 65.0	60.0 - 65.0
X2 cm	50.0	50.0	50.0
X3 cm (min-max)	-	-	35.4 - 40.4

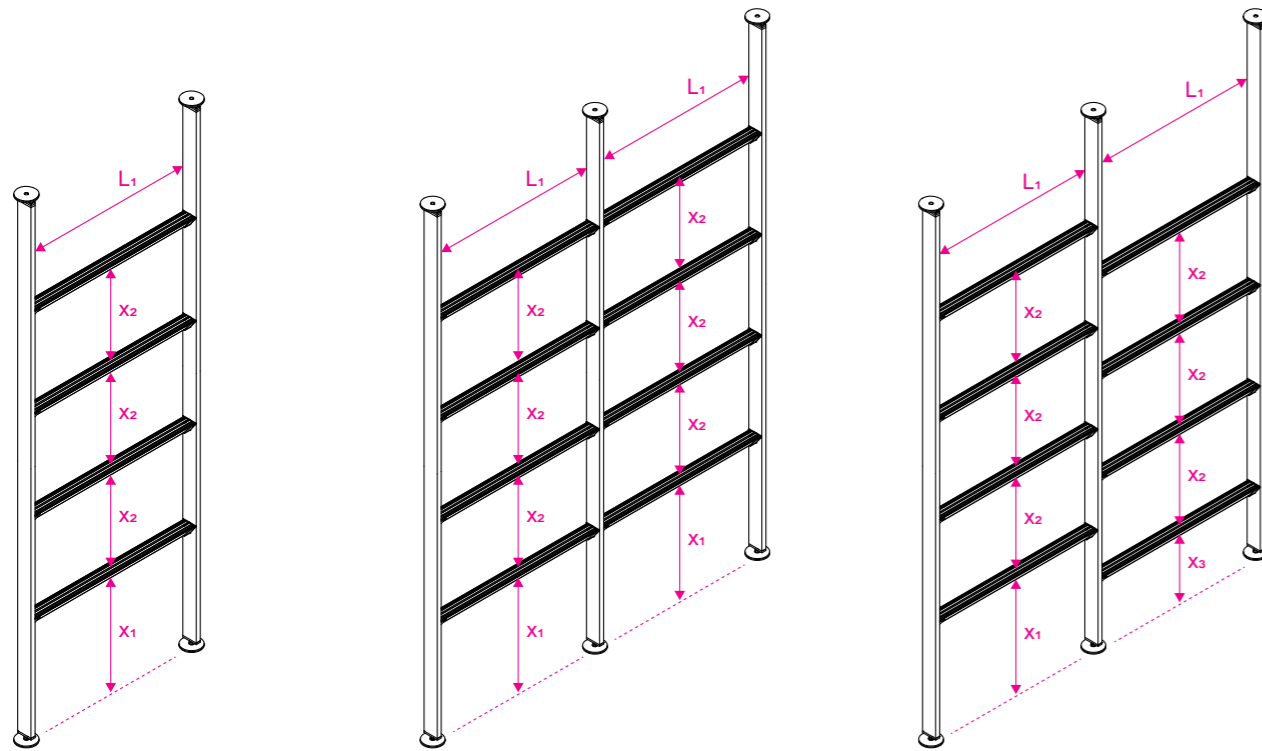

Giostra è un complemento per interni con dimensioni e misure diverse, che possono variare per adeguarsi alla perfezione a tutti i contesti dove l'impianto viene realizzato. Per questo, Giostra è adatto a edifici residenziali, uffici, centri commerciali perché il cliente può individuare la tipologia che più gli aggrada, con tutte le caratteristiche che desidera e richiede. Si possono avere maggiori informazioni mettendosi in contatto con l'azienda, per telefono o via posta elettronica.

Giostra is a furnishing accessory available in different sizes and shapes to provide you with a bespoke solution that perfectly fit in your space. For this reason, Giostra is suitable for residential buildings, offices and shopping malls. Every customer can choose the favourite structure and add the desired features on demand. For more information please contact the company, by phone or e-mail.

Джостра это дополнение к интерьеру разных размеров и высот, которые могут варьироваться, чтобы идеально подойти в любой контекст, в котором будут установлены. Джостра подходит для жилых помещений, офисов или торговых центров, позволяя клиенту подобрать нужный для него тип, со всеми необходимыми и желаемыми характеристиками. За дополнительной информацией обращайтесь в компанию по телефону или по электронной почте.

-  Verniciato ghisa
Painting cast iron
ОКРАСКА ЧУГУН
-  Titanio
Titanium
титан
-  Nero
Black
черный
-  Corten
Corten
ржавчина
-  Verniciato
Painting
ОКРАСКА



PIEDINI DI REGOLAZIONE

Grazie ai piedini di regolazione i montanti possono essere allineati e messi in tensione in modo solido e sicuro in tutta semplicità. Utilizzando i piedini di regolazione è possibile regolare l'altezza fino a 10 cm (5 cm in alto e 5 cm in basso).

ADJUSTING FEET

Thanks to the adjusting feet, you can easily align the pillars in a solid and safe manner. Using the adjustment feet you can adjust the height up to 10 cm (5 cm upward and 5 cm downward).

РЕГУЛИРУЕМЫЕ НОЖКИ

Благодаря регулируемым ножкам, несущие колонны будут выровнены, прочно и надежно отрегулированы простым способом. Ими можно скорректировать высоту до 10 см (5 см снизу и 5 см сверху).



INCASTRO BREVETTATO

La perfetta geometria ed il millimetrico dimensionamento dell'incastro permette di avere una solida tenuta (fino a 40 Kg per ogni barra orizzontale). L'innovativo sistema ad incastro, elimina la necessità di avvitare gli accessori alla struttura, garantendo velocità di montaggio e stabilità.

PATENTED JOINT

Perfect geometry and millimeter sizing of the joint allows for a solid endurance (up to 40 Kg for each horizontal bar). The innovative interlocking system eliminates the need for screwing the accessories to the frame ensuring a quick assembly and solidity.

ЗАПАТЕНТОВАННАЯ СИСТЕМА КРЕПЛЕНИЯ

Идеальная геометрия и точность паза до миллиметров, позволяет получить прочную устойчивость (каждая горизонтальная планка выдерживает до 40 кг). Инновационная система крепления защелкивания в паз, убирает необходимость иметь дополнительные крепежные элементы, но гарантирует скорость монтажа и стабильность структуры.



UTILITÀ BIFACCIALE

Grazie alle due barre orizzontali fissate sul montante verticale, Giostra è in grado di formulare molteplici soluzioni per la definizione architettonica degli ambienti. Con una sola struttura è possibile attrezzare due zone distinte, mantenendo sempre un design leggero e moderno.

TWO-SIDED UTILITY

Thanks to the two horizontal bars fixed to the vertical pillar, Giostra can offer multiple solutions for the architectural definition of the spaces. Just one single structure can furnish two distinct areas and yet keep a modern and smart design.

ДВУХСТОРОННЯЯ СИСТЕМА

Благодаря двум горизонтальным планкам, соединенные и зафиксированы на вертикальных несущих колоннах, Джостра может предложить многочисленные решения для определения архитектурных требований к помещению. Всего одна структура может оборудовать две разные зоны, сохраняя легкий и современный дизайн.



MODULARE

Una semplicità architettonica che assicura al progetto un'eccezionale versatilità, con la possibilità di realizzare composizioni anche di ampie dimensioni, in assoluta sicurezza. Affiancando più moduli è possibile comporre infinite soluzioni.



MODULAR

An architectural simplicity that assures the project an exceptional versatility, with the opportunity of creating compositions of even greater dimensions, in absolute safety. By joining multiple modules, it is possible to make infinite solutions.

МОДУЛЬНАЯ КОНСТРУКЦИЯ

Архитектурная простота, которая дарит исключительную многогранность системе, и дает возможность создавать даже большие структуры в полной безопасности. Соединяя дополнительные модули системы, можно создать бесконечное количество решений.

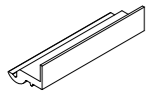
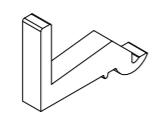
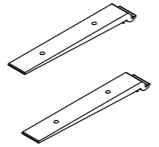
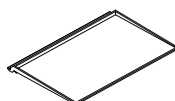
Accessori / Accessories / Аксессуары

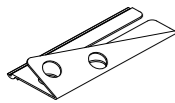
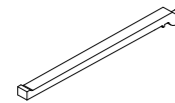
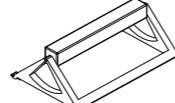
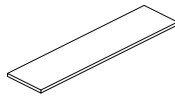
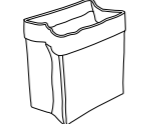
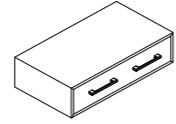
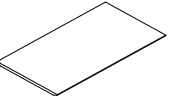
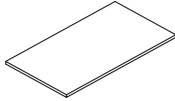
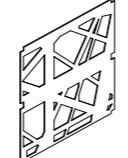
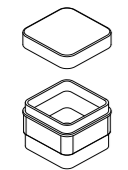
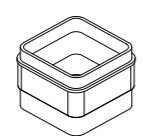
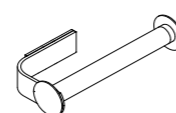
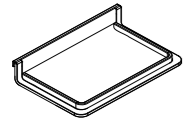
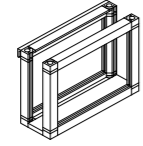
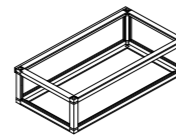
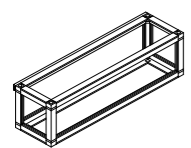
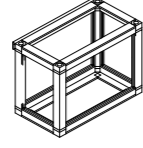
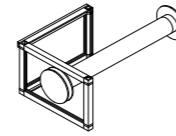
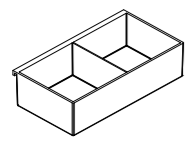
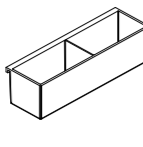
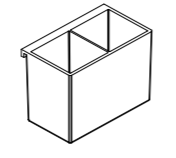
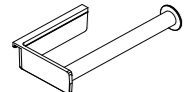
	Adattatore Adapter адаптор pagina 135		Gancio Hanger крючок pagina 134		Reggimensola Shelf support полкодержатель pagina 134
	Mensola 270 Shelf 270 полка 270 pagina 132		Mensola 450 Shelf 450 полка 450 pagina 132		Mensola 600 Shelf 600 полка 600 pagina 132
	Portabottiglie Bottle holder держатель для бутылок pagina 135		Portapentole Support pots держатель для кастрюль pagina 133		Portarotolo Roll holder держатель для бумажного полотенца pagina 133
	* Mensola legno 22 Wood shelf 22 деревянная полка 22 pagina 138		* Contenitori Containers контейнеры pagina 140		* Cassettiera Caisson ящик pagina 138
	* Mensola rovere 45 Durmast shelf 45 дубовая полка 45 pagina 138		* Mensola legno 50 Wood shelf 50 деревянная полка 50 pagina 138		Pannello ragnatela Web panel панель pagina 141
	* Contenitori Containers контейнеры pagina 126		* Contenitori Containers контейнеры pagina 126		* Portarotolo Roll holder держатель для бумажного полотенца pagina 127
	* Mensola Shelf полка pagina 126		* Portatovaglioli Napkins holder держатель для салфеток pagina 129		* Portabarattoli Jars holder держатель для баночек pagina 128
	* Portaspezie Spices holder держатель для специй pagina 128		* Portaposate Cutlery holder держатель для столовых приборов pagina 128		* Portarotolo Roll holder держатель для бумажного полотенца pagina 129
	* Portabarattoli Jars holder держатель для баночек pagina 124		* Portaspezie Spices holder держатель для специй pagina 124		* Portaposate Cutlery holder держатель для столовых приборов pagina 124
	* Portarotolo Roll holder держатель для бумажного полотенца pagina 125				

* Abbinare un accessorio ad un adattatore
Match an accessory to an adapter
Использовать один адаптор для
крепления контейнера

* Abbinare due ganci ad un sacchetto
contenitore
Match two hooks to a container bag
Использовать два крючка для
бумажного мешка – контейнера

* Abbinare una coppia di staffe reggimen-
sola alla mensola
Match a pair of brackets to the shelf
Использовать пару полкодержателей
для одной полки

* Abbinare due coppie di staffe reggimen-
sola alla mensola
Match two pairs of brackets to the shelf
Использовать две пары
полкодержателей для полки





GIOSTRA L

Organizzare lo spazio con eleganza e, nel contempo, secondo criteri di efficienza: questa è, in sintesi, Giostra L. I moduli, disponibili di serie in 3 larghezze, con possibilità di tagli a misura, per garantire al sistema massima flessibilità. Le mensole hanno due tipologie materiali: in legno o in acciaio, è possibile attrezzarla con pensili così da organizzare al meglio gli spazi per ogni ambiente.

How to arrange your space in a sophisticated and efficient way? Giostra L is the answer. The modules are available in 3 different widths, with the possibility of custom cuts to maximize the flexibility of the system. The shelves are available in two materials: wood or steel, it is possible to equip it with hangings to best arrange spaces in each room.

Джостра Эль элегантно и эффективно организует помещение. Модули доступны в 3 размерах, с возможностью резать их под нужный размер, чем гарантируют максимальную гибкость системы. Полки доступны в двух материалах – дерево или сталь, а также возможно дополнить систему ящиками, для лучшей организации пространства



GIOSTRA L



GIOSTRA L

GIOSTRA L 60/90/120

Materiale / Materials / МАТЕРИАЛ
Alluminio / Aluminium / Алюминий

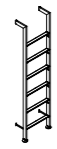

GIOSTRA_L/60

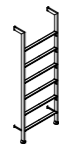

GIOSTRA_L/90

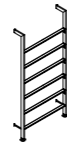

GIOSTRA_L/120

	GIOSTRA_L/60	GIOSTRA_L/90	GIOSTRA_L/120
Kg.	12.7	14.5	16.3
L cm	72.8	102.8	132.8
L1 cm	60.0	90.0	120.0
H cm (min-max)	268.0 - 274.0	268.0 - 274.0	268.0 - 274.0
P cm	29.7	29.7	29.7
X1 cm (min-max)	28.3 - 33.3	28.3 - 33.3	28.3 - 33.3
X2 cm	38.7	38.7	38.7

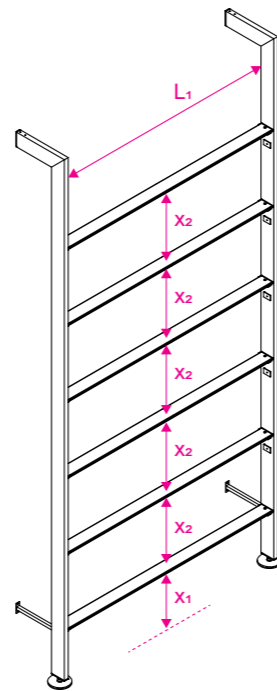
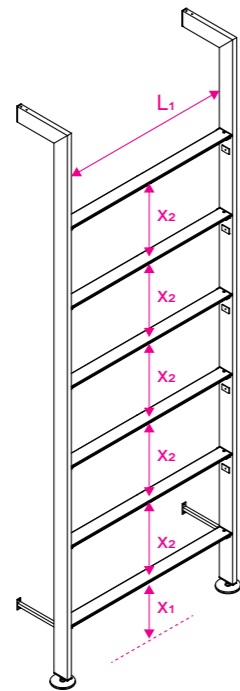
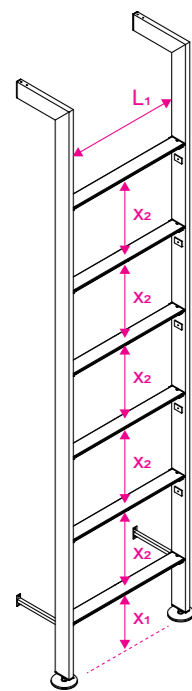

Giostra L è un complemento per interni con dimensioni e misure diverse, che possono variare per adeguarsi alla perfezione a tutti i contesti dove l'impianto viene realizzato. Per questo, Giostra è adatto a edifici residenziali, uffici, centri commerciali perché il cliente può individuare la tipologia che più gli aggrada, con tutte le caratteristiche che desidera e richiede. Si possono avere maggiori informazioni mettendosi in contatto con l'azienda, per telefono o via posta elettronica.

Giostra L is a furnishing accessory available in different sizes and shapes to provide you with a bespoke solution that perfectly fit in your space. For this reason, Giostra is suitable for residential buildings, offices and shopping malls. Every customer can choose the favourite structure and add the desired features on demand. For more information please contact the company, by phone or e-mail.

Джостра Эль это дополнение к интерьеру разных размеров и высот, которые могут варьироваться, чтобы идеально подойти в любой контекст, в котором будут установлены. Джостра подходит для жилых помещений, офисов или торговых центров, позволяя клиенту подобрать нужный для него тип, со всеми необходимыми и желаемыми характеристиками. За дополнительной информацией обращайтесь в компанию по телефону или по электронной почте.

-  Titanio
Titanium
титан
-  Nero
Black
черный
-  Verniciato
Painting
ОКРАСКА

Accessori / Accessories / Аксессуары

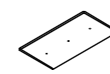

Mensola
Shelf
полка

pagina 139



Mensola
Shelf
полка

pagina 139

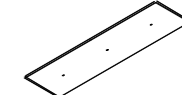

Mensola
Shelf
полка

pagina 139

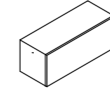

Pensile
Cabinet
подвесной ящик

pagina 139

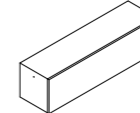

Pensile
Cabinet
подвесной ящик

pagina 139

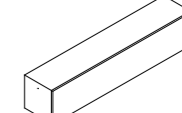

Pensile
Cabinet
подвесной ящик

pagina 139

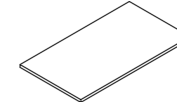

Mensola legno 50
Wood shelf 50
деревянная полка 50

pagina 138

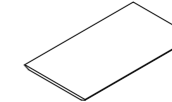

Mensola rovere 45
Durmast shelf 45
дубовая полка 45

pagina 138



PIEDINI DI REGOLAZIONE

Grazie ai piedini di regolazione i montanti possono essere allineati e messi in tensione in modo solido e sicuro in tutta semplicità. Utilizzando i piedini di regolazione è possibile regolare l'altezza fino a 5 cm.

ADJUSTING FEET

Thanks to the adjusting feet, you can easily align the pillars in a solid and safe manner. Using the adjustment feet you can adjust the height up to 5 cm.

РЕГУЛИРУЕМЫЕ НОЖКИ

Благодаря регулируемым ножкам, несущие колонны будут выровнены, прочно и надежно отрегулированы простым способом. Ими можно скорректировать высоту до 5 см.



MODULARE

Una semplicità architettonica che assicura al progetto un'eccezionale versatilità, con la possibilità di realizzare composizioni anche di ampie dimensioni, in assoluta sicurezza. Affiancando più moduli è possibile comporre infinite soluzioni.

MODULAR

An architectural simplicity that assures the project an exceptional versatility, with the opportunity of creating compositions of even greater dimensions, in absolute safety. By joining multiple modules, it is possible to make infinite solutions.

МОДУЛЬНАЯ КОНСТРУКЦИЯ

Архитектурная простота, которая дарит исключительную многогранность системе, и дает возможность создавать даже большие структуры в полной безопасности. Соединяя дополнительные модули системы, можно создать бесконечное количество решений.



TOTEM

Grazie alla sua particolare struttura ad un solo montante e con lampada di chiusura, Totem rappresenta un'ottima soluzione per riporre oggetti, illuminare e allo stesso tempo razionalizzare gli spazi. Realizzato in alluminio, ha in dotazione 4 mensole orientabili a 360° di varie dimensioni. La sua capacità di arredare gli ambienti, unita al suo design minimale ed elegante, la rende idoneo a qualsiasi contesto.

Thanks to its unique single-pillar structure and lamp on top, Totem is a great solution for storing objects, lighting and organizing spaces. It is made of aluminium and it comes with four 360-degree turntable shelves of various sizes. Because of its minimalist and elegant design, it furnishes your room and it is suitable for any space.

Благодаря своей особенной структуре, которая состоит из всего одной несущей колонны с лампой на вершине, Тотэм является отличным решением для размещения предметов, источником освещения, и в тоже время, организации пространства. Изготавливается из алюминия, в комплект входят четыре поворотные, на 360 градусов, полки, разных размеров. Его способность украшать помещения, в сочетании с минималистичным дизайном, делает его подходящим для любого контекста



AWARD 2017
Shortlisted

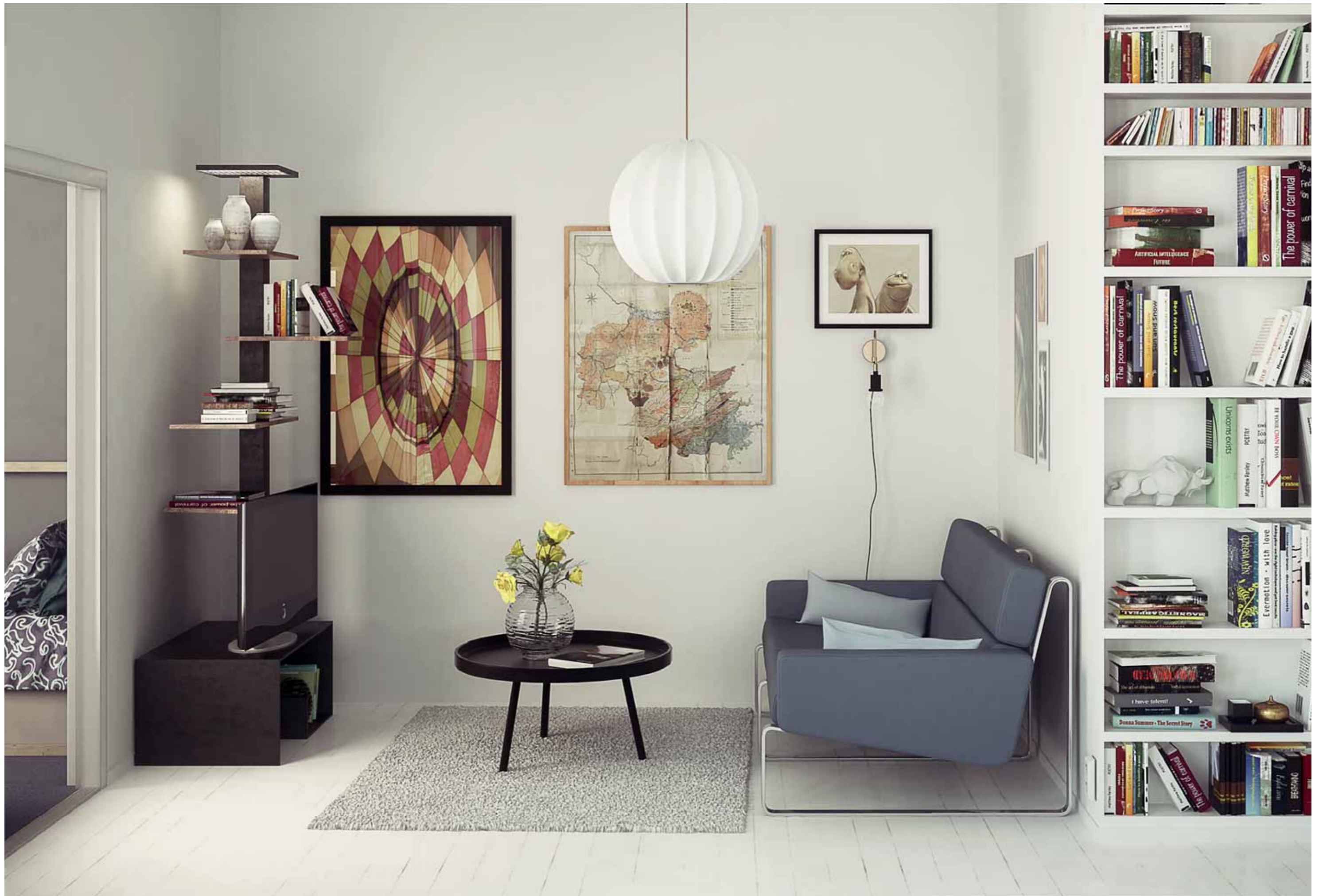

TOTEM

TOTEM



TOTEM

TOTEM

TOTEM

Materiale / Materials / МАТЕРИАЛ
Alluminio / Aluminium / Алюминий

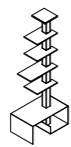

TOTEM

Kg.	31.3
L cm	80.0
H cm	210.0
P cm	50.0
X1 cm	35.0
X2 cm	48.0
X3 cm	32.3
X4 cm	33.1

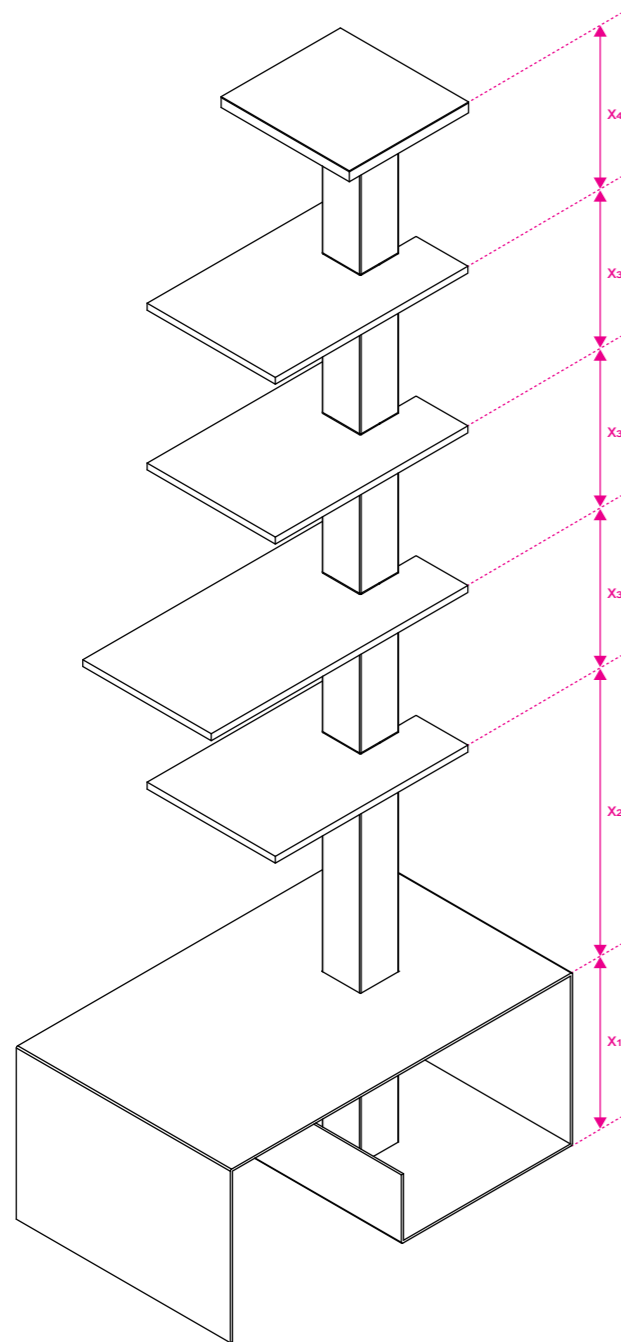

● Verniciato grigio
Painting gray
ОКРАСКА ЧУГУН

● Verniciato
Painting
ОКРАСКА

LED 6521 K
230 V CE



Accessori / Accessories / Аксессуары

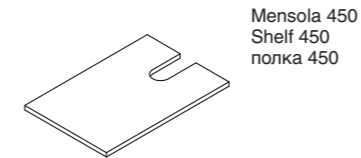

Mensola 450
Shelf 450
полка 450

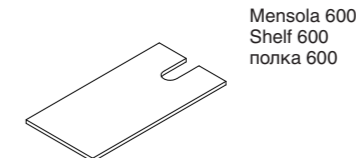

Mensola 600
Shelf 600
полка 600



DIMMERABILE CON SMARTPHONE

La lampada è dotata di tecnologia di controllo Bluetooth che consente all'utente di regolarne il funzionamento attraverso dispositivi smartphone e tablet. La tecnologia Bluetooth consente una comunicazione veloce, a lunghe distanze, anche in presenza di ostacoli, garantendo sempre bassissimi consumi. Lo smartphone o il tablet può controllare la lampadina singolarmente oppure controllare simultaneamente un gruppo di lampadine attraverso l'utilizzo della applicazione.

The lamp is equipped with Bluetooth control technology that enables the user to control it through smartphones and tablets. Bluetooth technology allows fast, long-distance communication, even if there are obstacles, always guaranteeing lower power consumption. Mobile devices can control either one single bulb or a group of bulbs at the same time by using a application.

В лампу встроен механизм контроля освещения при помощи Bluetooth, который позволяет пользователю регулировать освещения через смартфон или планшет. Технология Bluetooth работает быстро, на больших расстояниях, даже с присутствием барьеров, и гарантирует низкое энергопотребление. Через приложение на смартфоне или планшете можно регулировать каждую лампочку отдельно или все вместе.



ROTAZIONE A 360 GRADI

Grazie alla particolare sezione degli incastri, ogni mensola può ruotare di 360° intorno al montante centrale in alluminio che funge da perno. Le mensole diventano così pratiche e funzionali per ogni utilizzo.

360-DEGREE ROTATION

Due to the special cross-sectional area, each shelf can rotate 360° around the aluminium central pillar that acts as a pivot. In this way the shelves become practical and functional for every use.

ПОВОРОТЛИВОСТЬ НА 360 ГРАДУСОВ

Благодаря ряду особенных пазов, каждая полка может поворачиваться на 360 градусов вокруг центральной несущей колонны, которая служит опорой. Полки становятся практичными и функциональными для любого использования.



ILLUMINAZIONE

L'impianto luminoso è a LED quindi basso consumo e massima resa. Si può accendere e spegnere tramite pedaliera oppure è possibile regolare l'intensità tramite applicazione su smartphone.

LIGHTENING

The light system is LED for low consumption and maximum yield. It can be switched on and off via pedal or you can adjust intensity using an app on your smartphone

ОСВЕЩЕНИЕ

Система освещения ЛЕД, а это значит низкое потребление энергии, но большая светоотдача. Освещение можно регулировать при помощи выключателя или приложением для смартфона



TECA

Dallo stile caldo e tradizionale, Teca è perfetta per organizzare la cucina in modo pratico e funzionale. Costituita da una griglia in metallo fissata su un pannello in legno, le sue traverse orizzontali forate consentono di appendere qualsiasi oggetto mentre le sue mensole permettono di riporre anche elementi più grandi, tenendoli sempre a disposizione, matterello compreso. Più che un complemento d'arredo, una preziosa amica in cucina.

Classic and traditional country style. Teca is great to arrange the kitchen in a practical and functional way. It is composed of a metal grille fixed to a wooden panel, perforated horizontal crossbars to hang objects and shelves to store even larger items such as the roller. More than just an accessory, it is a precious friend in your kitchen.

Тэка благодаря своему теплому и традиционному стилю, идеально организует кухню простым и функциональным образом. Состоит из металлической рамки, которая крепится на деревянную панель. Горизонтальные планки, с отверстиями по всей длине, позволяют повесить все что нужно, а полки вмещают даже большие предметы, которые всегда будут под рукой, в том числе и скалку. Из мебельного аксессуара Тэка превращается в настоящую подругу на кухне.

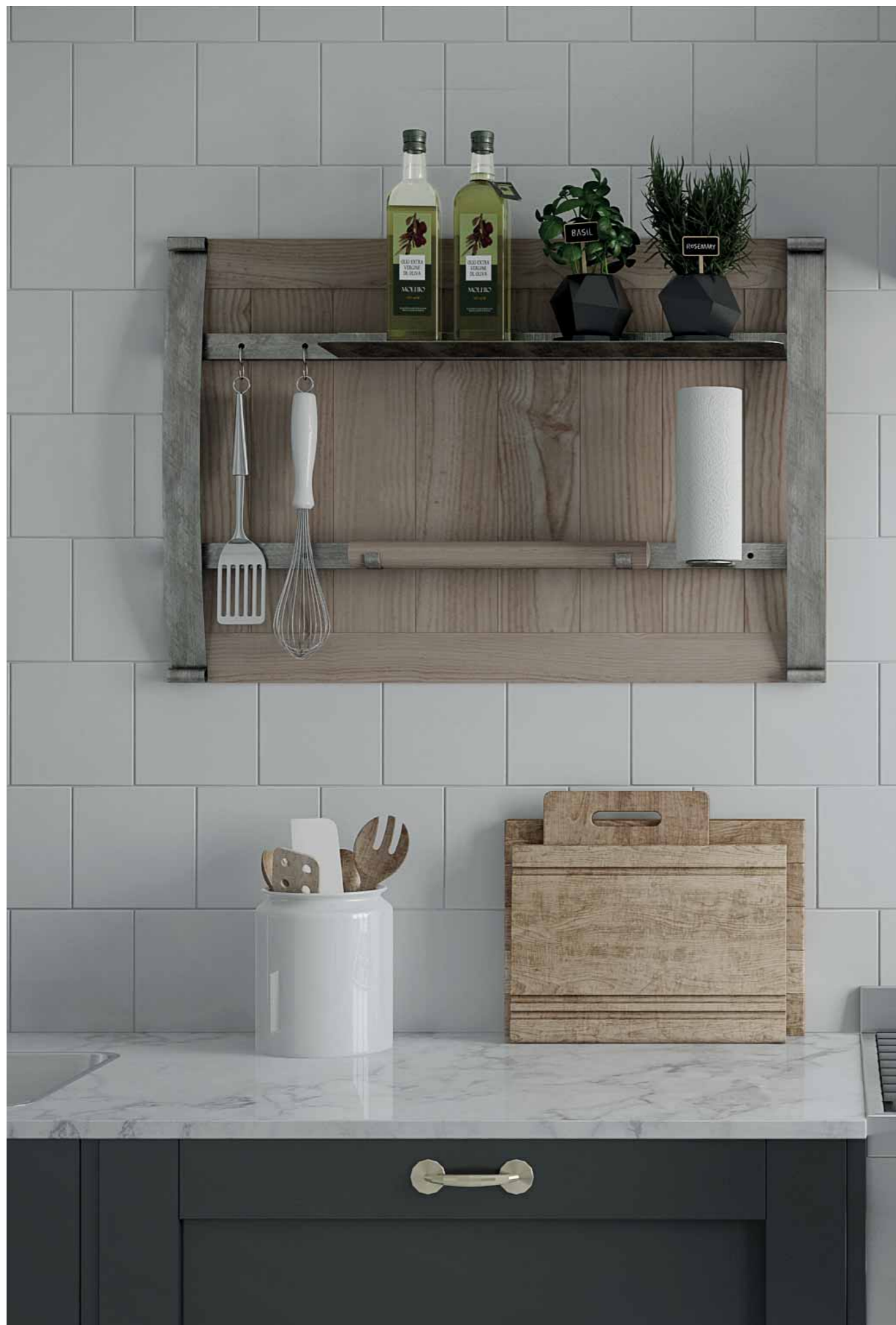

TECA



TECA

TECA 600

Materiale / Materials / МАТЕРИАЛ
Ferro / Iron / Железо



600x900

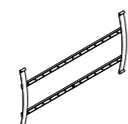

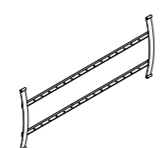

600x1200

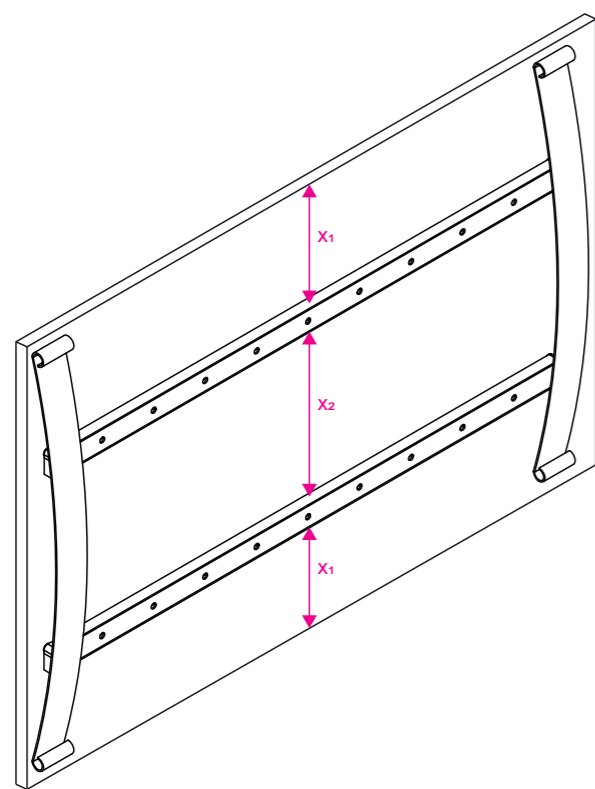

600x1500

	600x900	600x1200	600x1500
Kg.	2.8	3.3	3.8
L cm	90.0	120.0	150.0
H cm	60.0	60.0	60.0
P cm	5.0	5.0	5.0
X1 cm	13.0	13.0	13.0
X2 cm	24.5	24.5	24.5



-  Grigio canna di fucile
Barreled dark gray
пушечный порох
-  Verniciato
Painting
ОКРАСКА

Accessori / Accessories / Аксессуары

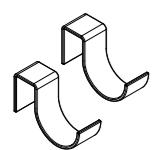

Gancio porta mattarello
Rolling pin holder
крючок держатель для
бумажного полотенца
pagina 136



Gancio
Hanger
крючок
pagina 137

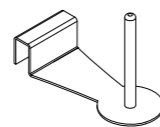

Portarotolo
Roll holder
держатель для
бумажного полотенца
pagina 136

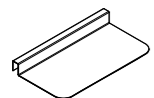

Mensola 300
Shelf 300
полка 300
pagina 136

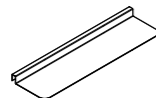

Mensola 600
Shelf 600
полка 600
pagina 136

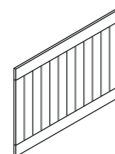

Pannello in legno
Wood panel
полка
pagina 137





FLY

Semplice e compatto, Fly organizza lo spazio del tuo bagno in modo estremamente razionale: con la sua struttura metallica sospesa, permette di avere a disposizione tutto il necessario e, contemporaneamente, di velocizzare le pulizie, donando anche un tocco di eleganza all'ambiente. Modulabile in altezza, questo portaoggetti ha la possibilità di essere arricchito con molti accessori pratici e funzionali.

Easy and compact. Fly helps you to organize your bathroom in an extremely efficient way. Thanks to its suspended metal structure you have everything you need at your fingertips, it is easy to clean yet elegant. This storage case it is a modular structure and can be personalised with many practical and functional accessories.

Флай – простой и компактный, организует пространство вашей ванной комнаты в очень рациональный способ. Его металлическая подвесная структура, позволяет иметь под рукой все необходимое, ускоряет уборку, и придает элегантную нотку помещению. Модульный по высоте, этот держатель для предметов может быть дополнен разными практичными и функциональными аксессуарами



FLY



FLY

FLY

Materiale / Materials / МАТЕРИАЛ
Ferro / Iron / Железо

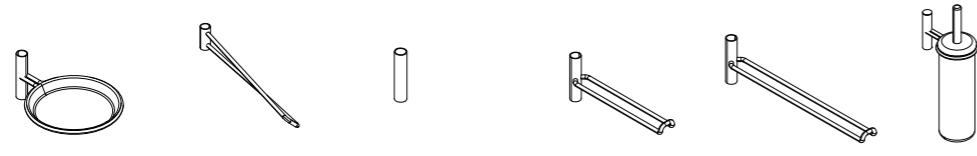

	FLY/MMU	FLY/PSS	FLY/DIS	FLY/PRS	FLY/PR2	FLY/PSC
Kg.	0.29	0.2	0.1	0.1	0.2	0.14
L cm	18.0	3.1	2.2	3.3	3.3	10.7
H cm	10.0	10.0	10.0	10.0	10.0	10.0
P cm	24.0	30.0	2.2	15.0	33.0	16.0

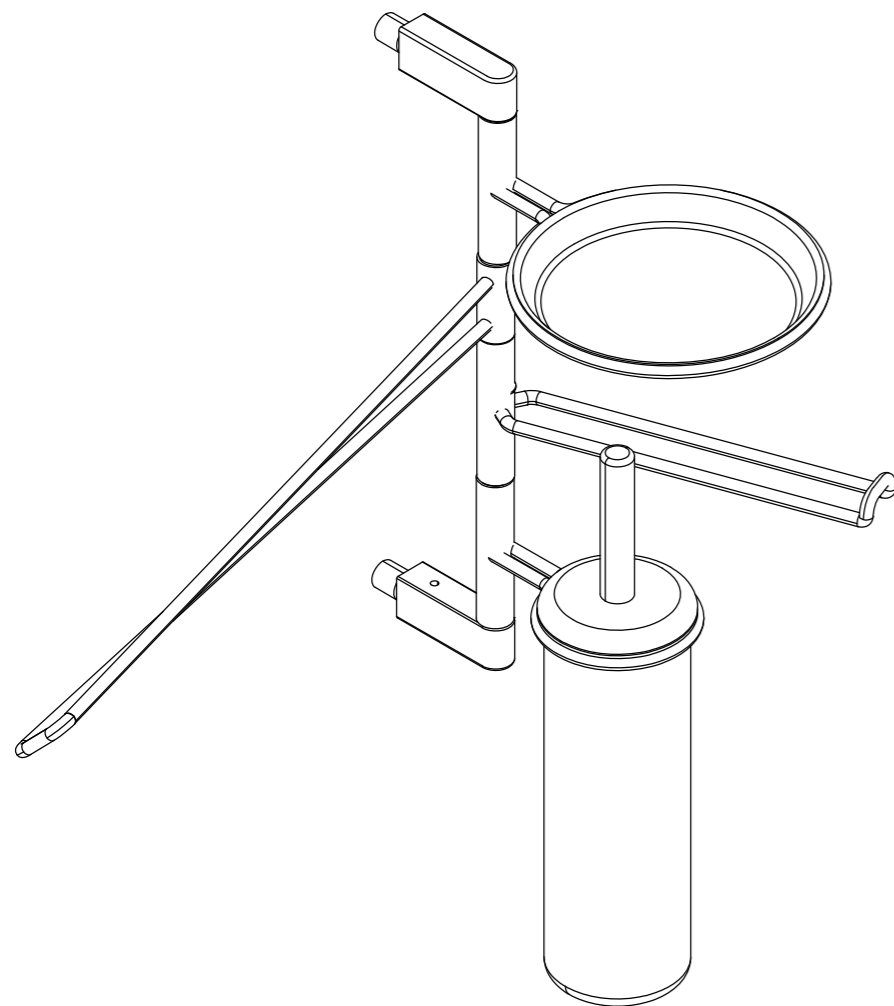

- Cromo lucido
Polish chrome
хром глянец
- Verniciato bianco
Painting white
ОКРАСКА БЕЛЫЙ

FLY



ROTAZIONE A 180 GRADI

Grazie alla particolare sezione degli incastri, ogni accessorio può ruotare di 180° intorno all'asse centrale. Gli accessori diventano così pratici e funzionali per ogni utilizzo, garantendo il massimo della personalizzazione in base alle proprie esigenze.

ROTATION TO 180 GRADES

Thanks to the special cross-sectional area, the accessories can rotate 180-degree around the central pillar. Making each part practical and functional for every use and ensuring maximum customization to suit your needs.

Поворачивание на 180 градусов

Благодаря ряду особенных пазов, каждый аксессуар может поворачиваться на 180 градусов вокруг центральной несущей колонны. Аксессуары становятся практичными и функциональными для любого использования, могут максимально персонализироваться согласно требованиям каждого



PERSONALIZZABILE

Grazie al suo particolare tipo di incastro, ogni composizione può essere realizzata in base alle esigenze estetiche e funzionali. Fly è completamente modulare, si possono comporre infinite soluzioni. L'attacco a parete è semplice e consente una perfetta pulizia del pavimento, mantenendo tutti gli accessori sospesi.

CUSTOMIZABLE

Thanks to its peculiar joint type type, each solution can be completely tailor-made to suit your aesthetic and functional requirements. Fly is completely modular, you can create endless combinations. The wall joint is easy and facilitates the floor cleaning, keeping all accessories suspended.

персонализация

Благодаря особенному типу паза, каждая композиция может быть выполнена согласно эстетическим и функциональным требованиям. Флай это полностью модульная система, и можно составить бесконечное количество решений. Простое крепление на стену позволяет производить уборку пола, не перемещая подвесные аксессуары системы

FLY

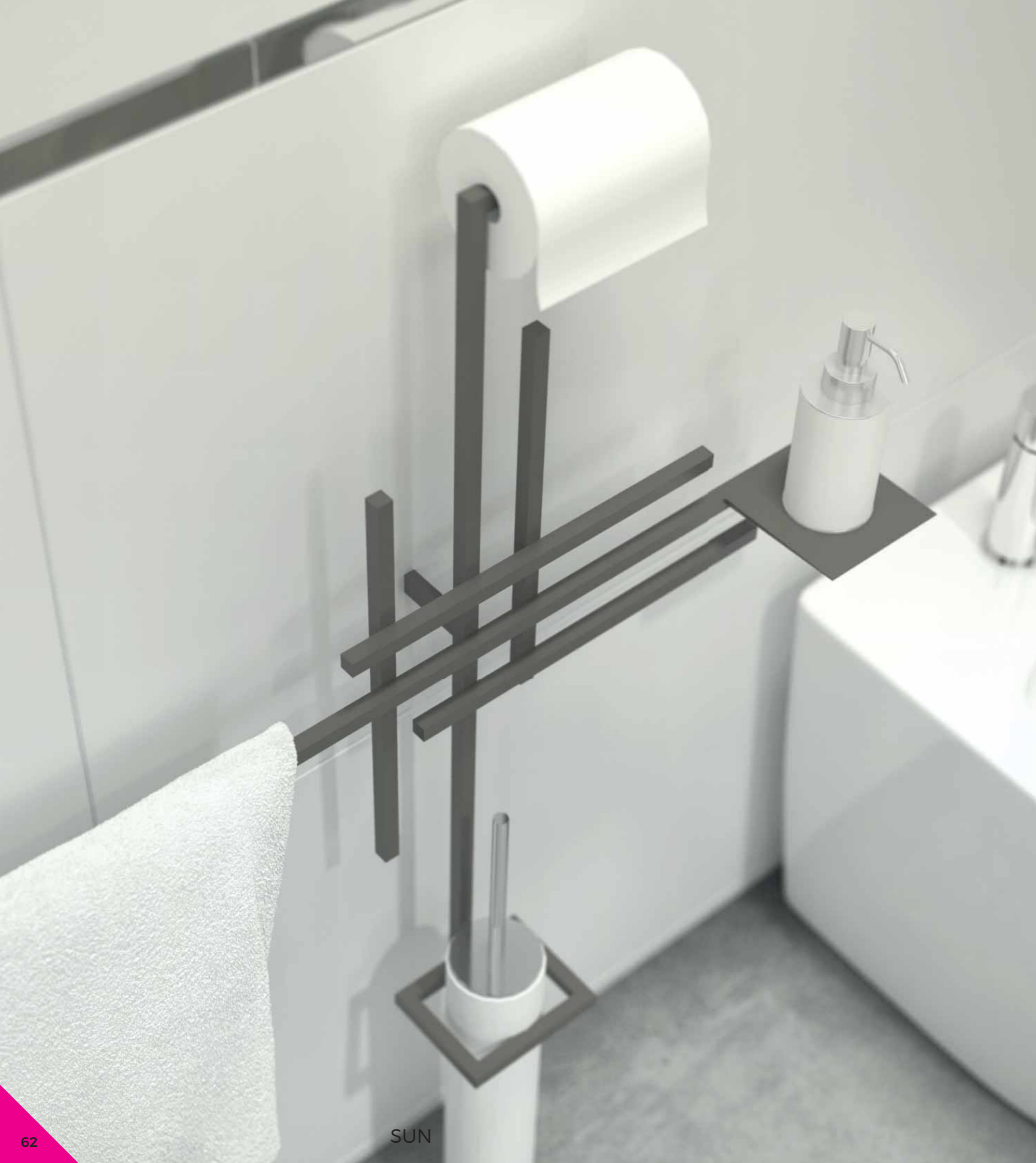

SUN

Incroci geometrici di linee in grado di organizzare in modo unico il tuo ambiente: Sun è il portaoggetti più sottile e meno ingombrante mai pensato per gli accessori del bagno. Grazie all'attacco puntuale e alla sua struttura sottile e metallica, ogni elemento può essere collocato sia in verticale che in orizzontale, seguendo le proprie esigenze di praticità e il proprio gusto estetico.

Sun is a geometric lines intersection to help you to furnish your bathroom in a unique way. It is the thinnest and the least bulky bathroom storage device ever designed. Thanks to its punctual attachment and its slim and metallic structure, each item can be placed either vertically or horizontally, depending on your needs and preferences.

Геометрические пересечения линий, которые могут организовать в уникальный способ твое пространство – это Сан, самый тонкий и менее габаритный держатель, когда-либо придуманный для предметов ванной комнаты. Благодаря аккуратному креплению и тонкой металлической структуре, на которой предметы могут располагаться вертикально и горизонтально, следуя требованиям практичности и эстетики



SUN

SUN

SUN

Materiale / Materials / МАТЕРИАЛ
Alluminio / Aluminium / Алюминий

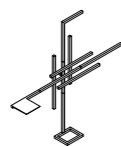

SUN

Kg.	1.05
L cm	48.0
H cm	42.5
P cm	6.0

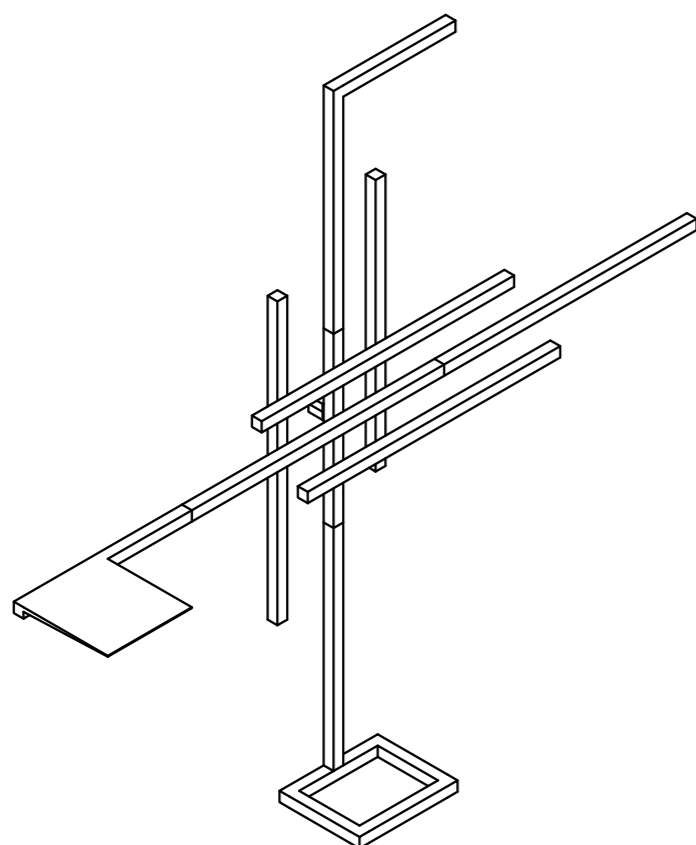

-  Nero
Black
черный
-  Cromo lucido
Polish chrome
хром глянec
-  Verniciato
Painting
ОКРАСКА

Accessori / Accessories / Аксессуары

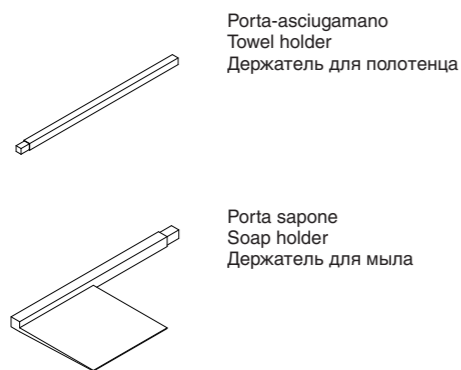

Porta-asciugamano
Towel holder
Держатель для полотенца

Porta sapone
Soap holder
Держатель для мыла

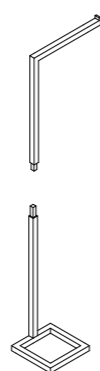

Porta cartaijenica
Toilet paper holder
Держатель для туалетной бумаги

Porta scopino
Toilet brush holder
Держатель для щётки

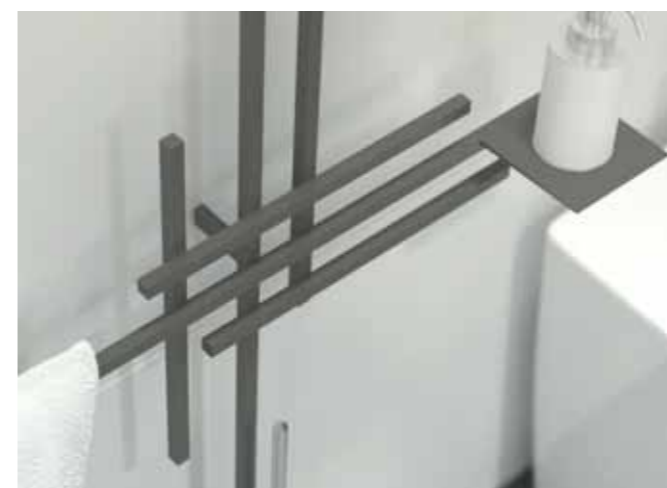

FACILE PULIZIA
Grazie al suo design semplice e geometrico, Sun è un'ottima soluzione per l'organizzazione dello spazio in bagno. L'attacco a parete è semplice e consente una perfetta pulizia del pavimento, mantenendo tutti gli accessori sospesi.

EASY CARE
Thanks to its simple and geometric design, Sun is a great solution for arranging space in the bathroom. The wall joint is easy and facilitates the floor cleaning while keeping all suspended accessories.

ПРОСТАЯ УБОРКА
Благодаря своему простому геометрическому дизайну, Сан это отличное решение для организации пространства в ванной. Простое крепление на стену позволяет производить уборку пола, не перемещая подвесные аксессуары системы.

UN ATTACCO "PUNTUALE"
Grazie all'attacco puntuale e alla sua struttura sottile e metallica è possibile avere ben 4 accessori per il bagno con un solo punto di fissaggio. Un'ottima soluzione per non dover riempire di fori le pareti del proprio bagno.

PRECISE JOINT
Thanks to its precise wall joint and its slim and metallic structure, it is possible to have 4 bathroom accessories with only one fastening point. An excellent solution for avoiding having lots of holes on bathroom walls.

АККУРАТНОЕ КРЕПЛЕНИЕ
Благодаря аккуратному креплению и тонкой металлической структуре, можно разместить до 4-х аксессуаров для ванной на одной точке крепления. Отличное решение, чтобы не сверлить бесконечное количество отверстий в собственной ванной.

CREATIVE COMBOS

ACCESSORI

Ogni nostro prodotto nasce per darti la possibilità di progettare e arredare qualsiasi ambiente seguendo le tue idee, la tua personalità e il tuo stile, in modo semplice e funzionale. Forme, colori e materiali sono per noi strumenti per creare combinazioni originali e soluzioni innovative che si adattino a te, ridisegnando i contorni della tua quotidianità. Sempre nuovo pur rimanendo lo stesso: è così che il tuo spazio vitale, la tua casa, il tuo ufficio, cambiano di pari passo con te e con l'evoluzione della tua storia personale, in una composizione potenzialmente infinita.

We create each of our products to enable you to design and furnish every room according to your own ideas, personality and style, in a easy and functional manner. Shapes, colours and materials are our working tools to realise original combinations and innovative solutions to best suit you and fit with your daily life. Always new while remaining the same: this is how your living space, your home, your office, will change with you and the evolution of your personal life, in an endless number of combinations.

Каждый наш продукт рождается, чтобы дать тебе возможность просто и функционально проектировать и обустраивать любое помещение согласно твоим идеям, твоему характеру, твоему стилю. Формы, цвета и материалы являются для нас инструментами, для создания оригинальных комбинаций и инновационных решений, которые подстраиваются под тебя, перечерчивая контуры твоей повседневной жизни. Всегда новое и в тоже время постоянное, твое личное пространство, твой дом, твой офис, меняются одновременно с тобой и с эволюцией твоей персональной истории, превращаются в мощную бесконечную композицию.

Portabarattoli / Jars holder / держатель для баночек

Materiale / Materials / МАТЕРИАЛ
Plastica / Plastic / Пластик

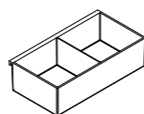

P-AM02

Kg.	0.4
L cm	27.0
H cm	7.5
P cm	14.7

Portarotolo / Roll holder / держатель для бумажного полотенца

Materiale / Materials / МАТЕРИАЛ
Plastica / Plastic / пластика

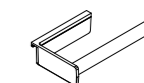
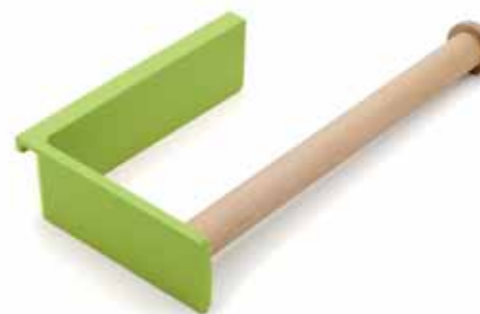

P-AM05

Kg.	0.2
L cm	24.5
H cm	4.5
P cm	12.1

Portaspezie / Spices holder / держатель для специй

Materiale / Materials / МАТЕРИАЛ
Plastica / Plastic / Пластик

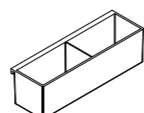

P-AM03

Kg.	0.2
L cm	13.0
H cm	10.0
P cm	7.6

Gancio / Hanger / крючок

Materiale / Materials / МАТЕРИАЛ
Alluminio / Aluminum / Алюминий

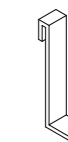

AM06

Kg.	0.005
L cm	1.0
H cm	5.2
P cm	1.7

-  Anodizzato lucido
Polished anodized
гляцевое
анодирование
-  Anodizzato spazzolato
Brushed anodized
шлифованное
анодирование
-  Verniciato
Painting
ОКРАСКА

Portaposate / Cutlery holder / держатель для столовых приборов



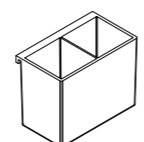





Materiale / Materials / МАТЕРИАЛ
Plastica / Plastic / Пластик



P-AM04

Kg.	0.2
L cm	13.0
H cm	10.0
P cm	7.6

Finiture disponibili/ Finishing available/ доступные покрытия

-  Acquamarina
Aquamarine
аквамарин
-  Bianco
White
белый
-  Rosso corallo
Coral red
красный корал
-  Vulcano
Volcan
серый вулкан
-  Giallo ambra
Amber
желтый янтарь
-  Bruno antilope
Antelope brown
бежевый
-  Salvia
Sage
зеленый
-  Lime
Lime
лайм
-  Rosa quarzo
Quartz pink
розовый кварц

Applicazioni/Applications/ применения

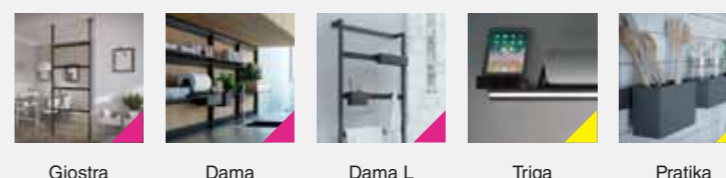

Giostra

Dama

Dama L

Triga

Pratika

Contentori / Containers / контейнеры

Materiale / Materials / МАТЕРИАЛ
Zama-Ceramica / Zamak-Ceramic / ЗАМАК – керамика



CPT01

Kg.	1.1
L cm	11.2
H cm	11.0
P cm	11.2

Portaspezie / Spices holder / держатель для специй

Materiale / Materials / МАТЕРИАЛ
Zama-Ceramica / Zamak-Ceramic / ЗАМАК – керамика

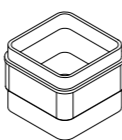

CPT02

Kg.	0.9
L cm	11.2
H cm	11.0
P cm	11.2

Mensola / Shelf / полка

Materiale / Materials / МАТЕРИАЛ
Zama-Ceramica / Zamak-Ceramic / ЗАМАК – керамика

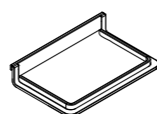

CPT04

Kg.	0.9
L cm	21.9
H cm	4.0
P cm	14.0

ACCESSORI

Portarotolo / Roll holder / держатель для бумажного полотенца

Materiale / Materials / МАТЕРИАЛ
Zama-Plexiglass / Zamak-Plexiglas / ЗАМАК – Плексиглаз

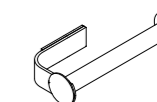

CPT03

Kg.	0.5
L cm	25.0
H cm	6.0
P cm	12.0

Finiture disponibili struttura / Structure finishing available/ доступные покрытия структуры



Cromo lucido
Polish chrome
хром глянцевый



Cromo satinato
Sateen chrome
хром матовый



Verniciato
Painting
ОКРАСКА

Finiture disponibili accessori ceramica /Pot accesories finishing available/ доступные покрытия аксессуаров



Verniciato bianco
Painting white
окраска белый



Verniciato tortora
Painting turtledove
окраска бежевый



Verniciato caffè
Painting coffee
окраска кофе

Applicazioni/Applications/ применения

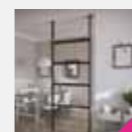

Giostra

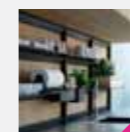

Dama

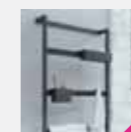

Dama L

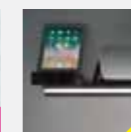

Triga



Compact

ACCESSORI

Portabarattoli / Jars holder / держатель для баночек

Materiale / Materials / МАТЕРИАЛ
Zama-Plexiglass / Zamak-Plexiglas / ЗАМАК – Плекси стекло

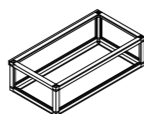

AM02	
Kg.	0.9
L cm	27.0
H cm	7.5
P cm	14.0

Portatovaglioli / Napkins holder / держатель для салфеток

Materiale / Materials / МАТЕРИАЛ
Zama-Plexiglass / Zamak-Plexiglas / ЗАМАК – Плекси стекло

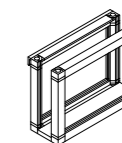

AM01	
Kg.	0.4
L cm	12.0
H cm	9.0
P cm	4.3

Portaspezie / Spices holder / держатель для специй

Materiale / Materials / МАТЕРИАЛ
Zama-Plexiglass / Zamak-Plexiglas / ЗАМАК – Плекси стекло

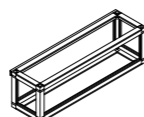

AM03	
Kg.	0.7
L cm	26.0
H cm	7.5
P cm	7.0

Portarotolo / Roll holder / держатель для бумажного полотенца

Materiale / Materials / МАТЕРИАЛ
Zama-Plexiglass / Zamak-Plexiglas / ЗАМАК – Плекси стекло

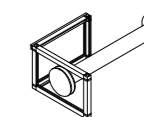
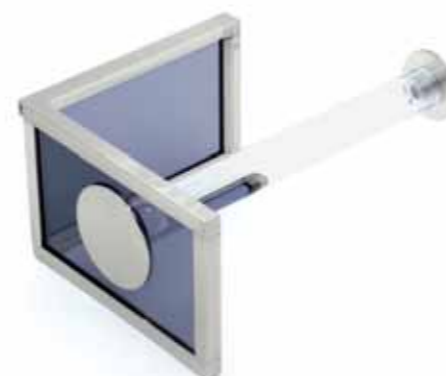

AM06	
Kg.	0.6
L cm	24.5
H cm	10.0
P cm	15.0

Portaposate / Cutlery holder / держатель для столовых приборов

Materiale / Materials / МАТЕРИАЛ
Zama-Plexiglass / Zamak-Plexiglas / ЗАМАК – Плекси стекло

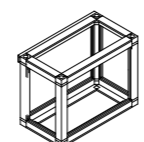

AM04	
Kg.	0.5
L cm	13.0
H cm	10.0
P cm	7.0

Finiture disponibili struttura / Structure finishing available/ доступные покрытия структуры

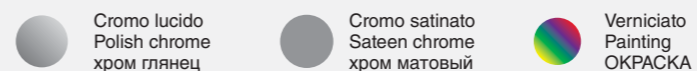

Finiture disponibili plexiglass/ Plexiglass finishing available/ доступные покрытия



Applicazioni/Applications/ применения



Giostra

Dama

Dama L

Triga

Mondrian

Mensola / Shelf / полка

Materiale / Materials / МАТЕРИАЛ
Alluminio / Aluminum / Алюминий



FRK02	
Kg.	0.2
L cm	30.0
H cm	5.0
P cm	10.0

Portarotolo / Roll holder / держатель для бумажного полотенца

Materiale / Materials / МАТЕРИАЛ
Alluminio / Aluminum / Алюминий



FRK01	
Kg.	0.04
L cm	3.0
H cm	5.0
P cm	10.0

Portaspezie / Spices holder / держатель для специй

Materiale / Materials / МАТЕРИАЛ
Alluminio-Plastica / Aluminum-Plastic / Алюминий-пластика

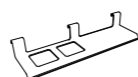
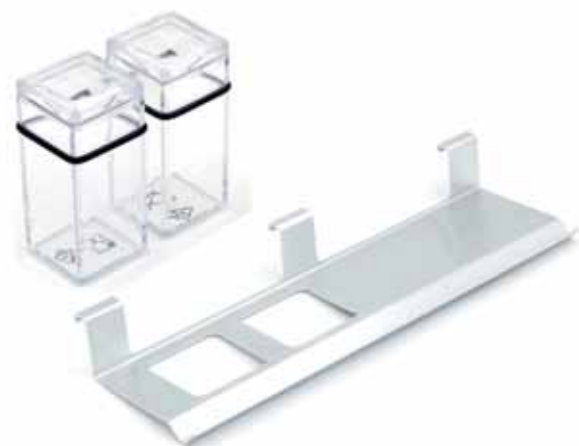

FRK06	
Kg.	0.3
L cm	30.0
H cm	5.0
P cm	10.0

Magnete / Magnet / магнит

Materiale / Materials / МАТЕРИАЛ
Alluminio / Aluminum / Алюминий



FRK04	
Kg.	0.03
L cm	2.5
H cm	4.0
P cm	1.25

Gancio / Hanger / крючок

Materiale / Materials / МАТЕРИАЛ
Alluminio / Aluminum / Алюминий



FRK05	
Kg.	0.01
L cm	2.5
H cm	3.9
P cm	3.2

Portaspezie / Spices holder / держатель для специй

Materiale / Materials / МАТЕРИАЛ
Alluminio-Plastica / Aluminum-Plastic / Алюминий-пластика

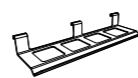

FRK03	
Kg.	0.5
L cm	30.0
H cm	5.0
P cm	10.0

Finiture disponibili/ Finishing available/ доступные покрытия



Anodizzato lucido
Polished anodized
глянцевое
анодирование



Anodizzato
spazzolato
Brushed anodized
шлифованное
анодирование



Verniciato ghisa
Painting cast iron
окраска чугуна



Verniciato
Painting
окраска

Applicazioni/Applications/ применения



Firkant

Mensola / Shelf / полка

Materiale / Materials / МАТЕРИАЛ
Alluminio / Aluminum / Алюминий



GIOSTRA/S-270

Kg.	0.4
L cm	27.0
H cm	1.0
P cm	17.0

Mensola / Shelf / полка

Materiale / Materials / МАТЕРИАЛ
Alluminio / Aluminum / Алюминий

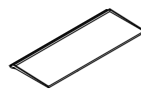

GIOSTRA/S-450

Kg.	0.8
L cm	45.0
H cm	1.0
P cm	17.0

Mensola / Shelf / полка

Materiale / Materials / МАТЕРИАЛ
Alluminio / Aluminum / Алюминий



GIOSTRA/S-600

Kg.	1.1
L cm	60.0
H cm	1.0
P cm	17.0

Portarotolo / Roll holder / держатель для бумажного полотенца

Materiale / Materials / МАТЕРИАЛ
Alluminio-Legno / Aluminum-Wood / Алюминий-Дерево

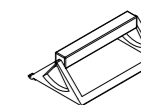

GIOSTRA-RH

Kg.	0.5
L cm	27.2
H cm	8.4
P cm	17.0

Portapentole / Support pots / держатель для кастрюль

Materiale / Materials / МАТЕРИАЛ
Alluminio / Aluminum / Алюминий

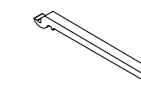

GIOSTRA/PH

Kg.	0.03
L cm	1.0
H cm	0.8
P cm	16.3

Finiture disponibili/ Finishing available/ доступные покрытия



Verniciato ghisa
Painting cast iron
окраска чугуна



Titanio
Titanium
титан



Nero
Black
черный



Corten
Corten
ржавчина



Bianco
White
белый

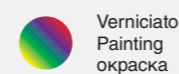

Verniciato
Painting
окраска

Applicazioni/Applications/ применения

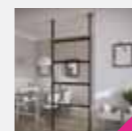

Giostra

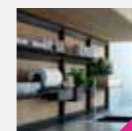

Dama



Dama L



Triga



Triga Slim

Reggimensola / Shelf support / полкодержатель

Materiale / Materials / МАТЕРИАЛ
Alluminio / Aluminum / Алюминий

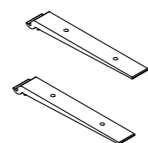

GIOSTRA/SH	
Kg.	0.1
L cm	3.0
H cm	1.3
P cm	20.0

Adattatore / Adapter / адаптор

Materiale / Materials / МАТЕРИАЛ
Alluminio / Aluminum / Алюминий

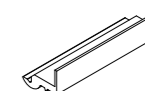

GIOSTRA/A	
Kg.	0.05
L cm	10.0
H cm	2.0
P cm	2.3

Gancio / Hanger / крючок

Materiale / Materials / МАТЕРИАЛ
Alluminio / Aluminum / Алюминий

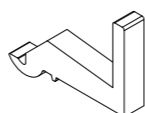

GIOSTRA/H	
Kg.	0.03
L cm	1.0
H cm	3.9
P cm	5.3

Portabottiglie / Bottle holder / держатель для бутылок

Materiale / Materials / МАТЕРИАЛ
Alluminio / Aluminum / Алюминий

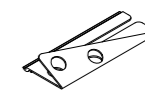

GIOSTRA/WH	
Kg.	0.3
L cm	27.0
H cm	4.5
P cm	10.0

Finiture disponibili/ Finishing available/ доступные покрытия

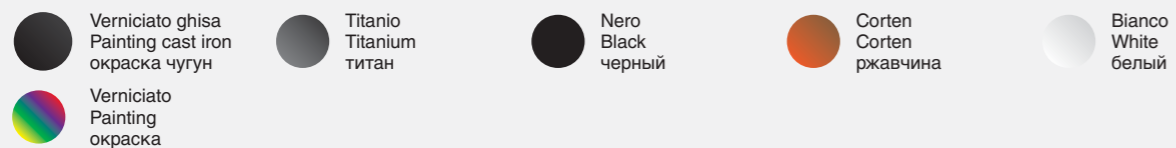

Applicazioni/Applications/ применения



Giostra Dama Dama L Triga Triga Slim

Finiture disponibili/ Finishing available/ доступные покрытия

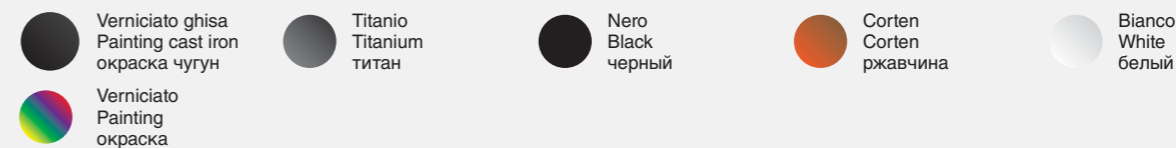

Applicazioni/Applications/ применения

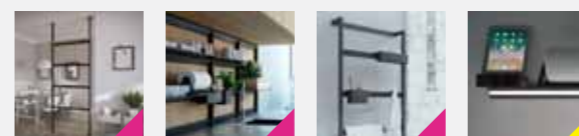

Giostra Dama Dama L Triga

Mensola / Shelf / полка

Materiale / Materials / МАТЕРИАЛ
Ferro / Iron / Железо

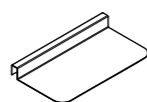

TECA/M300	
Kg.	0.9
L cm	30.0
H cm	3.5
P cm	17.0

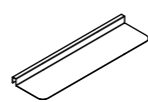

TECA/M600	
Kg.	1.5
L cm	60.0
H cm	3.5
P cm	17.0

Portarotolo / Roll holder / держатель для бумажного полотенца

Materiale / Materials / МАТЕРИАЛ
Ferro / Iron / Железо

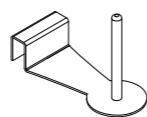

TECA/TR	
Kg.	0.2
L cm	6.0
H cm	10.0
P cm	15.0

Porta mattarello / Rolling pin holder / держатель для скалки

Materiale / Materials / МАТЕРИАЛ
Ferro / Iron / Железо

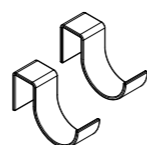

TECA/PM	
Kg.	0.04
L cm	2.0
H cm	3.6
P cm	6.2

Gancio / Hanger / крючок

Materiale / Materials / МАТЕРИАЛ
Ferro / Iron / Железо



TECA/H	
Kg.	0.02
L cm	6.0
H cm	5.0
P cm	0.5

Pannello in legno / wooden panel / деревянная панель

Materiale / Materials / МАТЕРИАЛ
Legno / Wood / Дерево



TECA/900	
Kg.	4.7
L cm	90.0
H cm	60.0
P cm	2.2



TECA/1200	
Kg.	6.3
L cm	120.0
H cm	60.0
P cm	2.2



TECA/1500	
Kg.	7.9
L cm	150.0
H cm	60.0
P cm	2.2

Finiture disponibili/ Finishing available/ доступные покрытия

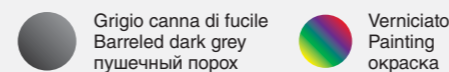

Finiture disponibili pannello in legno

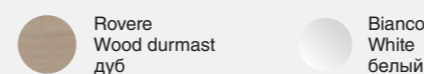

Applicazioni/Applications/ применения



Teca

Mensola / Shelf / полка

Materiale / Materials / МАТЕРИАЛ
Legno / Wood / Дерево

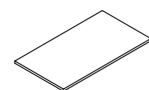

GIOSTRA/SW-45-R	
Kg.	6.5
L cm	90.0
H cm	2.0
P cm	50.0

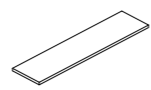

GIOSTRA/SWS	
Kg.	2.9
L cm	90.0
H cm	2.0
P cm	22.0

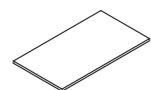

GIOSTRA/SW	
Kg.	6.5
L cm	90.0
H cm	2.0
P cm	50.0

Cassettiera / Caisson / ящик

Materiale / Materials / МАТЕРИАЛ
Legno / Wood / Дерево

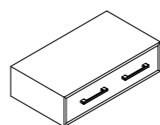

GIOSTRA/CA	
Kg.	18.3
L cm	90.0
H cm	20.0
P cm	50.0

Finiture disponibili/ Finishing available/ доступные покрытия

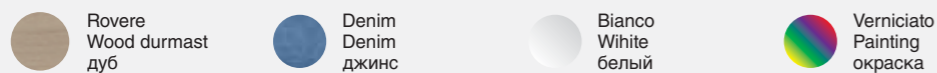

Applicazioni/Applications/ применения

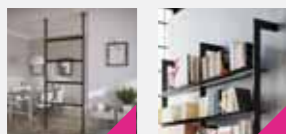

Giostra Giostra L

Mensola / Shelf / полка

Materiale / Materials / МАТЕРИАЛ
Alluminio / Aluminum / Алюминий



GIOSTRA-LU/S-600	
Kg.	1.9
L cm	60.0
H cm	2.0
P cm	31.0



GIOSTRA-LU/S-900	
Kg.	2.8
L cm	90.0
H cm	2.0
P cm	31.0

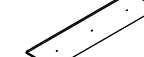

GIOSTRA-LU/S-1200	
Kg.	3.8
L cm	120.0
H cm	2.0
P cm	31.0

Finiture disponibili/ Finishing available/ доступные покрытия



Applicazioni/Applications/ применения



Giostra L

Pensile / Cabinet / подвесной ящик

Materiale / Materials / МАТЕРИАЛ
Legno / Wood / Дерево



GIOSTRA-LU/S-600	
Kg.	1.9
L cm	60.0
H cm	36.0
P cm	34.6

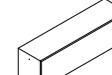

GIOSTRA-LU/S-900	
Kg.	2.8
L cm	90.0
H cm	36.0
P cm	34.6

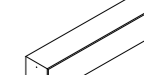

GIOSTRA-LU/S-1200	
Kg.	3.8
L cm	120.0
H cm	36.0
P cm	34.6

Finiture disponibili/ Finishing available/ доступные покрытия

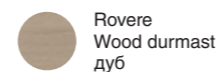

Applicazioni/Applications/ применения



Giostra L

Contenitori / Containers / контейнеры

Materiale / Materials / МАТЕРИАЛ
Cellulosa / Cellulose / Целлюлоза



	SCH/S	SCH/M	SCH/L
Kg.	0.1	0.2	0.3
L cm	8.0	14.0	40.0
H cm	10.0	16.0	30.0
P cm	5.5	9.5	20.0

Finiture disponibili/ Finishing available/ доступные покрытия



Applicazioni/Applications/ применения



Giostra Dama Dama L Triga

Cerro porta coltelli / knife block / держатель для ножей

Materiale / Materials / МАТЕРИАЛ
Legno / Wood / Дерево



	TAGLIERE
Kg.	0.6
L cm	31.0
H cm	21.0
P cm	1.8

Finiture disponibili/ Finishing available/ доступные покрытия



Applicazioni/Applications/ применения



Horizon

Portarotolo / Roll holder / держатель для бумажного полотенца

Materiale / Materials / МАТЕРИАЛ
Alluminio / Aluminum / Алюминий

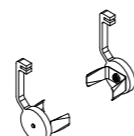

	HORIZON/PR
Kg.	0.087
L cm	VAR
H cm	11.9
P cm	5.9

Finiture disponibili/ Finishing available/ доступные покрытия



Applicazioni/Applications/ применения



Horizon Horizon Big

Pannello ragnatela / Panel / панель

Materiale / Materials / МАТЕРИАЛ
Legno / Wood / Дерево

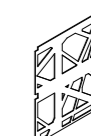

	GIOSTRA/PANN
Kg.	3.4
L cm	90.3
H cm	100.0
P cm	0.65

Finiture disponibili/ Finishing available/ доступные покрытия



Applicazioni/Applications/ применения



Giostra

Portarotolo bagno / Roll holder / держатель для бумажного полотенца

Materiale / Materials / МАТЕРИАЛ
Alluminio / Aluminum / Алюминий

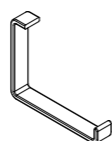

HB-PR	
Kg.	0.1
L cm	2.0
H cm	12.0
P cm	9.5

Porta riviste / Magazines holder / Держатель для журналов

Materiale / Materials / МАТЕРИАЛ
Alluminio / Aluminum / Алюминий

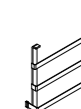

HB-PG	
Kg.	0.3
L cm	32.2
H cm	27.2
P cm	5.6

Porta dispenser / Soap dispenser holder / Держатель для жидкого мыла

Materiale / Materials / МАТЕРИАЛ
Alluminio / Aluminum / Алюминий



HB-PD	
Kg.	0.1
L cm	7.4
H cm	21.8
P cm	11.5

Gancio / Hanger / крючок

Materiale / Materials / МАТЕРИАЛ
Alluminio / Aluminum / Алюминий



HORIZON/H	
Kg.	0.1
L cm	1.0
H cm	6.8
P cm	2.0



HB/H	
Kg.	0.1
L cm	2.0
H cm	10.0
P cm	2.0

Porta spugne / Sponge holder / держатель для мочалок и мыла

Materiale / Materials / МАТЕРИАЛ
Alluminio / Aluminum / Алюминий

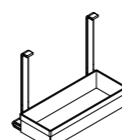

HB-PS	
Kg.	0.75
L cm	30.0
H cm	19.0
P cm	12.0

Finiture disponibili/ Finishing available/ доступные покрытия



Anodizzato spazzolato
Brushed anodized
шлифованное анодирование



Verniciato ghisa
Painting cast iron
окраска чугуна



Verniciato
Painting
окраска

Applicazioni/Applications/
применения

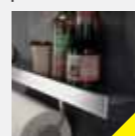

Horizon

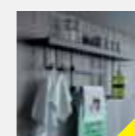

Horizon big



DAMIANO
LATINI

NORMATIVE

I colori sono puramente indicativi poiché dipendono dalla qualità della stampa.

I componenti elettrici gestiti presso il nostro magazzino rispettano tutti gli standard di qualità e le normative vigenti.

Damiano Latini declina ogni responsabilità per eventuali errori o inesattezze e si riserva di modificare senza preavviso le caratteristiche dei prodotti illustrati.

Sono tassativamente vietate le riproduzioni per fini commerciali di immagini e disegni tecnici senza specifica autorizzazione da parte di Damiano Latini srl.

Per ulteriori informazioni visitate il sito www.damianolatini.it
Catalogo aggiornato a Giugno 2017.



DAMIANO LATINI

Via Sandro Pertini, 63812
Montegranaro (FM) Italy
T +39 0734 894144
info@damianolatini.it
www.damianolatini.it

REGULATIONS

Colours are purely indicative as they depend on the print quality.

All electrical components operated at our warehouse are compliant with quality standards and regulations in force.

Damiano Latini refuses any responsibility for any errors or inaccuracies and reserves the right to modify without notice features of all displayed products.

Any kind of reproduction of images and technical drawings for commercial purposes are strictly forbidden unless expressly authorised by Damiano Latini srl.

For more information visit our web site www.damianolatini.it
Catalogue updated to June 2017.



SOCIAL



НОРМАТИВНЫЕ ТРЕБОВАНИЯ

Указанные цвета являются строго индикативными, поскольку зависят от качества печати. Все электрические компоненты, которые администрируются на нашем складе, отвечают всем стандартам качества и действующим нормам.

Дамиано Латини уклоняется от всякой ответственности за все ошибки или неточности, и сохраняет за собой право без предупреждения менять характеристики проиллюстрированных товаров. Категорически запрещено использовать в коммерческих целях фотографии и технические рисунки без авторизации со стороны Дамиано Латини.

За дополнительной информацией по продуктам, пожалуйста, посетите наш сайт: www.damianolatini.it
Каталог обновлен в июне 2017.



Damiano Latini S.r.l.
Via Sandro Pertini, 63812
Villaggio del lavoro località Piane del Chienti
63812 Montegranaro (FM) - Italy
T 0039 0734 894144 - F 0039 0734 894152
info@damianolatini.it - www.damianolatini.it