

DOME® BY HEATSAIL

SUMMER NIGHTS SHOULD LAST FOREVER

OUTDOOR LIGHTING & HEATING



HEATSAIL

SALES@HEATSAIL.COM | WWW.HEATSAIL.COM



DOME® TIMELESS LIGHTING WITH HEATING FOR YOUR GARDEN OR TERRACE

DOME® BY HEATSAIL

No better background scenery for a nice long conversation than
a sultry summer night!

Why don't we just make it a little warmer and lighter outside?
So those summer nights can last forever...

HEATSAIL PRODUCTS ARE DESIGNED AND MADE IN BELGIUM



Rustproof &
weatherproof



Low energy usage
zero CO2 emission



Minimum of
maintenance



HEATSAIL





**SUMMER ATMOSPHERE
AT THE PUSH OF A BUTTON**

Enjoy great food and drinks outdoors in a relaxed and lovely summer atmosphere.



**AN ATMOSPHERE TAILORED TO SUIT
EVERY EVENT**

Our DOME® has an SGS North America listed mark by UL norm 60335.



OPEN YOUR EYES. FEEL. EXPERIENCE.

Try out the atmosphere but be sure to enjoy the place and the moment.



DOME® FLOOR LAMP

A timeless lighting type with heating for your garden, terrace or patio.

Available in two heights:

- 180 cm (71 inch) clear vertical height suitable for dining table or lounge.
- 195 cm (77 inch) clear vertical height for use as party table or in areas such as smoking rooms.



**KEEP YOUR EAR TO THE GROUND FOR THE
LATEST INNOVATIONS**

You can now listen to wireless music thanks to integrated bluetooth.



EYE-CATCHER

The DOME® breathes luxury, elegance and exclusivity and it is the eye-catcher of your terrace or patio.



DOME® PENDANT

Give your ceiling that little added extra. You can turn your ceiling into a delightful jewel. The DOME® hanging lamp allows you to enjoy longer evenings.



TRENDY WHITE

White is pure, timeless and elegant. It lends itself well in a neutral and clear way to any interior style, from stylish classic to sleek modern.

Or timeless black?
Always in harmony with current trends.



THE DESIGN OF THE DOME® EXUDES
ELEGANCE AND MAKES IT THE FOCAL
POINT IN ANY SETTING...

PRODUCTS



FLOORLAMP

A 100% state-of-the-art Belgian product with a timeless design and almost maintenance-free.



PENDANT WITH WALL BRACKET

DOME® Pendant with wall bracket.



HANGING LAMP

DOME® Pendant with stem.
Max. height ceiling 3m56 (11 feet and 8.16 inches)



CONTROL

A switch with 2 positions for the heating: 1500 or 3100 Watt.
Switch for the lamp, a remote control unit to dim the lamp.



WHEELS

You can also opt for the version equipped with 4 instead of 2 wheels.



COVER

Protect the DOME® with an optional cover.



EXTENSION PIECE

Use the extension piece to create clearance height of 195 cm (77 inch) instead of the standard 180 cm (71 inch).



EXTRA WEIGHT

The base of the DOME® is supplied with 130 kg of weight. Metal plates can be added for extra weight when using it in windy areas.



DOME® HT

The DOME® HT generates up to 25% more heat with the same energy consumption.



RAL COLOUR

The DOME® is available in the standard colours of black or white. Optionally, the DOME® is also available in all RAL colours.

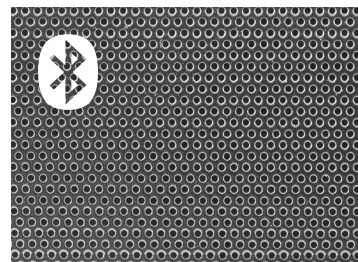

BLUETOOTH MUSIC

BLUETOOTH 4.0 connection with 2x 80 Watt waterproof speakers built into the base of the DOME®.



ASSEMBLY ACCESSORY

To simplify the assembly of the DOME® you are best off using our TRIPOD. This will allow you to set up the DOME® within 30 minutes.

TECHNICAL SPECIFICATIONS

ENERGY

| | |
|----------------|-----------|
| Consumption | 3,22 kw/h |
| Infra-red heat | 3100 Watt |
| Lighting | 120 Watt |

UK VERSION

| | |
|----------------|-----------|
| Consumption | 2,97 kw/h |
| Infra-red heat | 2850 Watt |
| Lighting | 120 Watt |

RADIATING RANGE OF 5 METRES (16 FEET AND 4.85 INCHES)

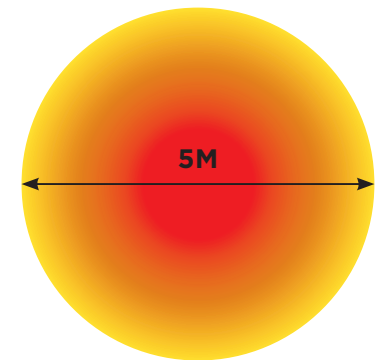

DIMENSIONS

| | |
|---------------|------------------------------|
| Diameter hood | 100cm (40 inch) |
| Hood height | 50cm (20 inch) |
| Base | 43x43x32cm (17x17x12.5 inch) |

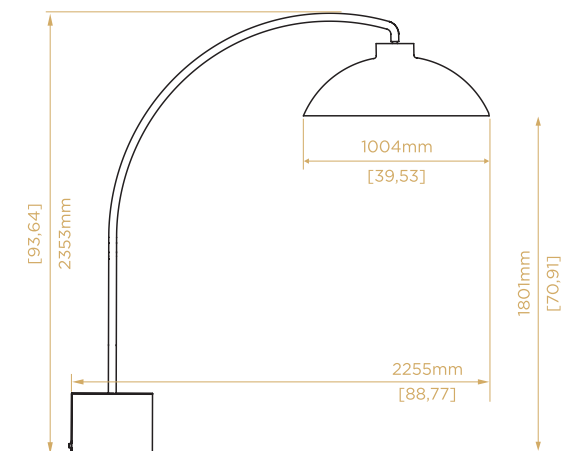

DESIGNED AND MADE IN BELGIUM



DOME® LIGHT BY HEATSAIL

EXTEND YOUR GREAT MOMENTS

INDOOR & OUTDOOR LIGHTING

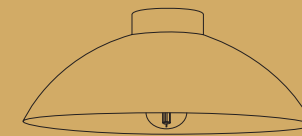

DOME® TIMELESS INDOOR AND OUTDOOR LIGHTING

DOME® LIGHT BY HEATSAIL

With its timeless design and industrial look DOME® LIGHT creates a unique atmosphere for your living or work environment.

Give your ceiling that little added extra. Turn it into a delightful jewel with DOME® LIGHT.



1100 LUMEN
11 WATT



VERY LOW
CONSUMPTION



LED
DIMMABLE



HEATSAIL

SALES@HEATSAIL.COM | WWW.HEATSAIL.COM

EN

BEEM® BY HEATSAIL

EXTEND YOUR GREAT MOMENTS

OUTDOOR LIGHTING AND HEATING



HEATSAIL

SALES@HEATSAIL.COM WWW.HEATSAIL.COM

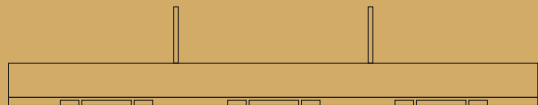

BEEM® TIMELESS PENDANT LIGHTING AND HEATING FOR YOUR TERRACE

BEEM® BY HEATSAIL

BEEM® is a timeless heating & lighting product that turns your terrace into a place you don't want to leave during cool cosy evenings.

Give your terrace that little added extra. Turn it into a delightful jewel with BEEM®.

HEATSAIL PRODUCTS ARE DESIGNED AND MADE IN BELGIUM



Rustproof & weatherproof



Low energy usage
zero CO2 emission



Minimum of maintenance



HEATSAIL





LIGHTING



HEATING



MISTING



PRODUCTS AND TECHNICAL SPECIFICATIONS

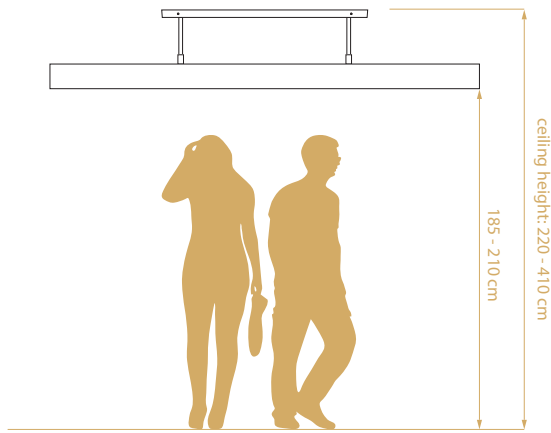

DESIGNED AND MADE IN BELGIUM

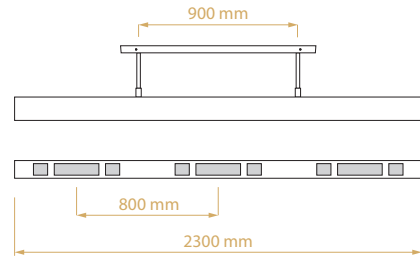

| | | |
|-------------------------|-------------------------|--|
| B230 | | |
| Infra-red heat | 3000 Watt | |
| Lighting | 6 x 16 Watt | |
| Electrical requirements | | |
| Fuse | 16 amp | |
| Wiring | 3 x 2,5 mm ² | |

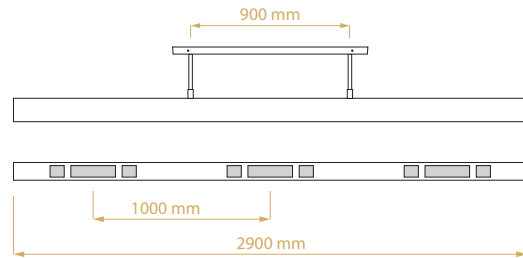

| | | |
|-------------------------|-------------------------|--|
| B290 | | |
| Infra-red heat | 3000 Watt | |
| Lighting | 6 x 16 Watt | |
| Electrical requirements | | |
| Fuse | 16 amp | |
| Wiring | 3 x 2,5 mm ² | |

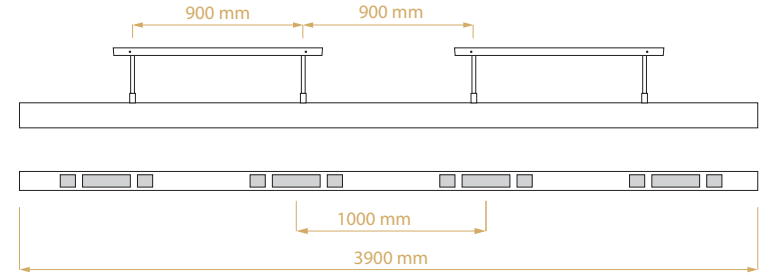

| | | |
|-------------------------|---|--|
| B390 | | |
| Infra-red heat | 4000 Watt | |
| Lighting | 8 x 16 Watt | |
| Electrical requirements | | |
| Fuse | 20 amp | |
| Wiring | 5 x 2.5 mm ² or (2x) 3 x 2.5 mm ² | |

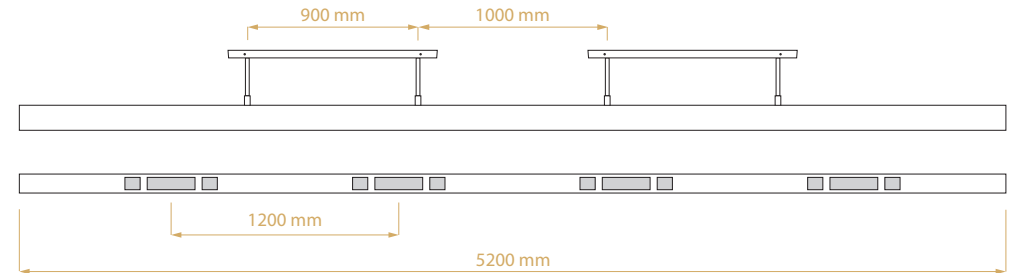

| | | |
|-------------------------|---|--|
| B520 | | |
| Infra-red heat | 4000 Watt | |
| Lighting | 8 x 16 Watt | |
| Electrical requirements | | |
| Fuse | 20 amp | |
| Wiring | 5 x 2.5 mm ² or (2x) 3 x 2.5 mm ² | |

HEATSAIL NV

Prins Boudewijnlaan 7 Unit A 08
2550 Kontich
Belgium

+32 3 502 99 88
info@heatsail.com

www.heatsail.com

HEATSAIL USA Inc

10440 N Central Expressway, Suite 800
75231 Dallas, Texas
United States of America

+1 214 808 5091
info@heatsail.com

www.heatsail.com



HEATSAIL

SALES@HEATSAIL.COM | WWW.HEATSAIL.COM